

EP HENRY®

CONTRACTOR

Technical Installation Guide

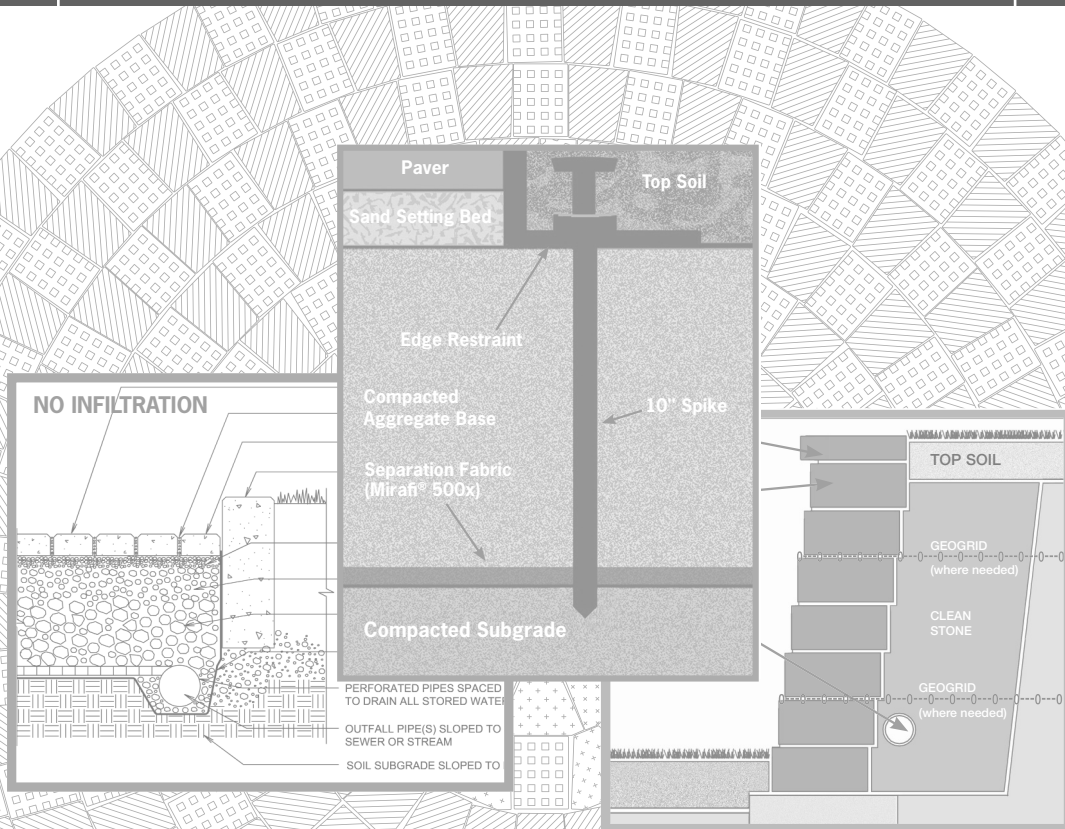

Contents



Pavers & Slabs

- 2 Paver Installation
- 4 Paver FAQ's
- 5 Paver & ECO™ Paver Patterns
- 7 ECO™ Paver Installation
- 8 DevonStone® FAQ's
- 9 DevonStone® Patterns
- 10 LASTRA Porcelain Slab Installation

Walls

- 12 Coventry® Wall & Tudor Wall™ Installation
- 13 Coventry® Wall III Installation
- 14 Double Sided Coventry® Wall Installation
- 14 Double Sided Tudor Wall™ Installation
- 14 Double Sided Cast Stone Wall™ Installation
- 16 Rustic Double Face Wall Installation
- 17 Cast Stone Wall™ & Terrace Wall™ Installation
- 18 StoneWall® SELECT® Installation
- 18 Mesa® Retaining Wall Installation
- 18 Diamond Pro® Installation
- 18 Vertica® Wall Installation
- 19 Wall Installation Details
- 23 Cast Stone Wall™ Grid Charts
- 26 Wall FAQ's
- 27 **Cast Veneer Stone™ Installation**

Accessories

- 29 Paver Accessories
- 30 Wall Accessories
- 31 Paver & Wall Lights
- 33 **Quick Reference**



Note to Homeowners: Prior to undertaking an installation yourself, it is recommended that you read these guidelines thoroughly and attend a DIY seminar at your local EP Henry Authorized Hardscaping Distributor®. A schedule of seminars and more detailed installation information can be found at ephenry.com.

Interlocking concrete pavers are installed successfully by professionals and do-it-yourselfers alike. These instructions are designed to be a basic guide. Detailed instructions can be obtained from EP Henry or your EP Henry Authorized Hardscaping Distributor.

MATERIALS NEEDED

Stone Base: Should be 3/4" modified stone, also known as 2A, or 3/4" quarry blend. A 1" depth of compacted base weighs approximately 1,000 lbs. per 100 sf. Always add 5 to 10 percent for edges and miscellaneous areas.

Bedding Sand: Coarse concrete sand is recommended. At a depth of 1", this weighs approximately 1000 lbs. per 100 sq. ft. Figure an extra 5 percent for jointing sand.

Pavers: Are typically sold by the square foot. Calculate the square footage needed for your project and add 5 to 10 percent for overage, cuts, waste, etc.

Edge Restraint: All exposed edges must be restrained.

Separation Fabric/Geotextiles: Recommended for all installations and critical where clay type soils are present. This will help maintain the integrity of the base.

TOOLS:

- Wooden stakes
- Wide blade mason's chisel
- 6'-8' 2"x4" or 2"x6"
- Mason's string (twine)
- Stiff bristle street broom
- Small pry bar
- 3-5 pound hammer
- Hard tooth garden rake
- 4' level
- 25' tape measure
- Flat shovel
- Wheelbarrow
- Diamond blade wet saw
- Chalkline
- 3-5 HP vibrating plate compactor
- Wire cutters (for cutting bands on pavers)
- 1" diameter sand screed guides (galvanized steel)

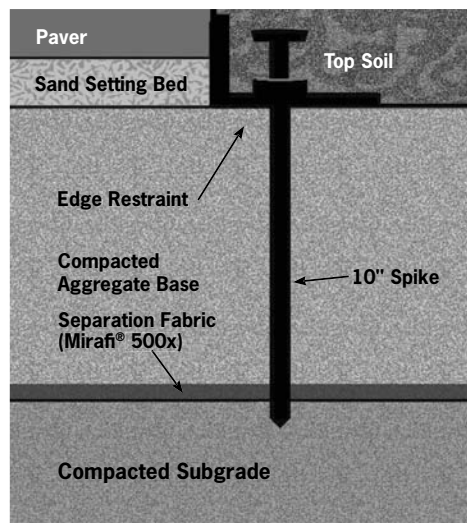

Typical Installation Cross Section

LAYOUT & PREPARATION

Measure the area you intend to pave. Determine square footage (length x width = square feet) adding 5 to 10 percent for cuts and extra pavers that might be needed later. Measure the linear feet of all edges not up against a permanent structure, such as a house, etc., to determine the amount of edge restraint needed. Draw a plan on a piece of paper showing all important dimensions. Mark the outline of your project with stakes every 4'-6' and at each corner. These stakes should be 8" outside of the planned edge of the finished pavement.

EXCAVATION

Note: Before digging, always call your local utility companies to locate any underground lines.

In general terms, a minimum of 6" of compacted aggregate base is recommended for patios and walkways, and 10" for residential driveways where freeze-thaw conditions exist. Add 3" for the depth of the bedding sand and the thickness of a standard 2 3/8" paver to determine the total depth to excavate. Excavation should be 6" wider than the finished pavement's dimensions on sides where edge restraint is to be used.

Slope and grade are important to ensure proper runoff. It is best to plan at least a 1/4" per foot drop, but try not to exceed 3/8" per foot.

BASE PREPARATION

As with any building project, the finished pavement will only be as good as the construction of the base. For this reason, this is the most important part of the installation process.

First, run your plate compactor over the excavated area, making sure that soil does not get stuck to the bottom of the plate tamper. Each pass should overlap the previous one by about 4". Compaction should be performed in one direction (North-South), then a second time at a right angle (East-West) to the first compaction. It is recommended that a separation fabric, such as Mirafi® 500x, be laid down over the compacted subgrade and returned up the sides of the excavation.

Now spread your stone base material out evenly in a 2" layer. If the material is dry and dusty, use a garden hose to evenly moisten it down. This helps make the gravel easier to rake and faster to compact. Starting around the outer perimeter, use the plate compactor to pack together the base, again overlapping each pass about 4", and working towards the center. You should make at least two complete passes for each layer. Repeat this process for each subsequent layer of base material until the final thickness is achieved.

When finished with the base, it should be very smooth and flat, and reflect the final grade of your pavers. If the surface deviation is greater than 3/8", then it should be filled in with base material. A deviation that is less than that should be filled in with the screed material, which is always coarse washed concrete sand for paver installations.

SAND SETTING BED

Note: It is important to keep your sand dry. Always keep your sand covered in case of rain. It is suggested that you only screed sand for areas where you will be laying pavers that same day.

Do not attempt to level any area or surface irregularities with the sand. This will result in an uneven surface and unwanted settling. Lay the screed guides (1" outside diameter electrical conduit, strips of wood or other suitable rigid material) on top of the compacted base material 4'-6' apart and parallel.

Evenly distribute a quantity of bedding sand between the guides and drag the 6'-8' 2"x4" or 2"x6" over the guides to create a smooth, even layer of sand, striking off any excess. When the pavers are set on the sand and compacted, the 1" of sand will compress to 3/8" to 1/2" thickness. Do not walk on or work from your sand. Fill voids left by the screed guides with sand and trowel them smooth as you are laying the pavers.

CONCRETE SAND VS. SCREENINGS FOR THE SETTING BED

According to the Interlocking Concrete Pavement Institute (ICPI), coarse concrete sand, i.e., sand used to make ready-mixed concrete, is recommended for the setting bed. Do not use stone dust or screenings for the setting bed. These materials do not drain water and become soft over time. Pavers will not seat properly in them when compacted. This will prevent interlock.

For the best results in all applications, ICPI recommends mason's sand to fill the joints. This sand is finer than concrete sand. It is the type of sand used to make mortar for masonry wall construction. Polymeric Sands for the joints are also acceptable as long as they are comparable to mason's sand in particle size.

Note: All projects must start at a perfect 90° angle. Use the 3-4-5 triangle method to establish this. For an even mix of pavers, draw from several cubes at a time when installing them.

LAYING THE PAVERS

Starting from a permanent edge such as a house, driveway, or even a piece of rigid PVC edge restraint, lay your first paver starting from either side. As you start laying pavers, work from right to left, then left to right, and so on, one row of pavers at a time. Set the pavers lightly onto the sand; never press or hammer them in. Every 4' or so, run a string across the front of the laying edge to maintain straight lines. If you are doing the project over a couple of days, cover the entire area with plastic overnight if rain is expected.

CUTTING THE PAVERS

Mark any stones to be cut with a wax crayon and use either a diamond blade wet saw (recommended) or a dry saw, a paver splitter, or a hammer and chisel may be used, but the edge they produce will be rough and uneven. Try to keep cut pieces along the edges to a size at least that of one half paver. Always wear safety glasses.

INSTALLATION OF EDGE RESTRAINT

Restrain all edges that are not up against a permanent structure with an appropriate product. Any restraint material should rest entirely on the compacted aggregate base.

SEAT THE INSTALLED PAVERS IN THE BEDDING SAND

Sweep the pavers clean prior to compacting. Cut a length of Mirafi® 500x or similar fabric to be used as a medium between the tamper and the pavers. Start tamping around the perimeter and, working inward, keep the fabric between the tamper and pavers. Make at least two passes over the pavers, overlapping each pass 2"-4". Make the second pass at a 90° angle to the first. This step will level the pavers and compact them into the bedding sand, filling the joints with sand from below.

FINISH FILLING JOINTS WITH SAND

Spread joint sand over pavers. Use a stiff bristle street broom and sweep back and forth over the entire paver surface until all joints are filled to the top with sand. Sweep off all excess sand. Again, use Mirafi 500x or a similar medium between the tamper and the pavers. Start tamping around the perimeter and, working inward, keep the fabric between the tamper and the pavers. Make at least two passes over the pavers, overlapping each pass 2"-4". Make the second pass at a 90° angle to the first. This final step will force the sand into the joints of the pavers creating an interlocking pavement. After compacting the pavers, sweep with sand again if needed.

BULLNOSE PAVERS INSTALLATION

Bullnose Pavers are typically used as stair treads, wall capping, and pool coping. The two recommended options for installation are: mortared-in-place using standard masonry procedures or glued down with a high strength flexible concrete adhesive.

Mortared-in-Place Installation:

Lay out the Bullnose Pavers in the area where they are to be installed, leaving a 3/8" gap for the mortar between the pavers. Bullnose Pavers are traditionally installed with a 1/2"-1" overhang. Remove the pavers and place an appropriate thickness of mortar on the material to which they are being affixed. Carefully return the pavers to their appropriate places and press into the mortar. Fill joints between the Bullnose Pavers with mortar.

Note: Be careful not to get any mortar on the paver surface, as it is very difficult to remove. If you do get mortar on the pavers, allow it to dry, then carefully remove using a stiff bristle brush or, for chunks, a putty knife.

Installation Using High Strength Flexible Concrete Adhesive:

Lay out the Bullnose Pavers in the area where they are to be installed, abutting one to another. Bullnose Pavers are traditionally installed with a 1/2"-1" overhang. Following the directions of the adhesive manufacturer, remove the pavers and run a continuous bead of adhesive on the material to which they are being affixed, from the front of the Bullnose Paver towards the rear. Carefully return the pavers to their appropriate place and press into the adhesive, being careful not to get any on the paver surface.

Note: See adhesive manufacturer's instructions for handling, clean-up, and cure time.



DON'T SCUFF THOSE PAVERS!

Manufacturers of plate compactors recommend the use of mats or membranes between the compactor and pavers to protect the pavers from surface damage. Most sell accessories for this purpose.

Pavers with profiled tops — Old Towne Cobble™, Coventry® Stone II, Coventry Stone III, Coventry Stone IV, Coventry Cobble, Coventry Estate Cobble, and Bristol Stone™ are most susceptible to damage from plate compactors. These pavers have high and low points molded into the surface, preventing the equipment from riding flat and subjecting the high points to potential scuffs. However, even smooth, flat surfaces can be damaged with improper usage or the existence of debris on the plate.

EP Henry recommends that you ALWAYS protect profiled top pavers prior to tamping by placing a medium between the plate compactor and the pavers. Recommended products include:

- Mirafi 500x (BEST)
- Luan plywood
- Rubber Mat
- Thin carpeting
- Cardboard

Caution: Dry sawing or grinding of concrete products may result in the release of respirable crystalline quartz. Prolonged exposure to respirable crystalline quartz may cause delayed (chronic) lung injury (silicosis). The use of a NIOSH-Approved respirator and tight-fitting goggles are recommended when sawing or grinding operations are in progress.

CALL 811 BEFORE YOU DIG!

Whether it's a paver job or a retaining wall, contractors are legally required to provide utility notification before ANY excavation. You'll need to give at least two to three business days notice, but typically not more than 10 days. Be prepared to describe your work and then plan on staying 2' away from any markings near your project.

JUST DIAL 811 NATIONWIDE.

Remember, you are liable for all damage and repair costs if you do not call!



Note about DevonStone® Installation: Our DevonStone line of cast stone slabs is created using a different manufacturing process than our non-wet cast pavers. Please go to ephenry.com for complete installation instructions for DevonStone including differences in base prep, unit spacing, cleaning and sealing and other important considerations.

WHY DO EP HENRY PAVERS MAKE THE IDEAL PAVEMENT?

Our pavers are the ideal product for freeze-thaw environments. Proper installation of the product results in a pavement that is rigid, yet flexible. The joints between pavers allow the walkway, driveway, and patio to move without cracking. In addition, they can be “unzipped” to allow for repairs or access to utilities. Unlike asphalt, pavers are virtually maintenance-free. By definition, concrete pavers have a minimum compressive strength of 8,000 PSI (about three times stronger than regular poured concrete) and a maximum water absorption rate of 5 percent.

WHY ARE THEY CALLED INTERLOCKING CONCRETE PAVERS?

It is the system that makes them interlocking concrete pavers, not necessarily the shape. When installed properly, the combination of the pavers, bedding sand, edge restraint, and joint sand causes them to interlock, allowing them to work as a unified, flexible pavement.

TELL ME MORE ABOUT THE DURAFACING™ PROCESS.

Durafacing is the trade name EP Henry uses for our process of creating what is known in the industry as a “face mix” paver. Durafacing is a sophisticated process, requiring a higher level of manufacturing equipment and skill, which produces an enhanced surface texture with exceptional strength. This technique came from Europe which is where most paver technology originated. Non- “face mix” manufacturers, who classify their products as “mono” or “one piece” pavers, counter with claims that “two piece” or “face mix” pavers will delaminate. This is simply not true and EP Henry supports this with our Lifetime Warranty. For more information on EP Henry’s Durafacing process, visit ephentry.com.

HOW DO I DETERMINE HOW MUCH MODIFIED STONE BASE MATERIAL AND SAND I'LL NEED?

As a rule of thumb, use a minimum of 6" of base material for walkways, 6'-8" for patios, and 10"-12" for driveways. The sand setting bed should be 1" thick. One ton of modified stone or sand will cover 100 sf at 2" thick. Using a 10'x10' (100 sf) patio as an example, you would need 1/2 ton of sand for the setting bed (1" thick) and three tons of modified stone for the base (6" thick). You'll need some additional sand (about 5 percent) or about two bags of Polymeric Sand for the joints between the pavers.

SOMEONE RECOMMENDED THAT I USE A FABRIC UNDER MY INSTALLATION. WHEN AND WHERE IS IT USED?

EP Henry recommends a geotextile separation fabric (e.g., Mirafi® 500x) under all paver installations. The fabric is laid on top of the compacted soil in the excavated area and keeps the aggregate base material from working its way into the soil subgrade. This is especially important where the soil contains a lot of clay. At a cost of pennies per square foot, the separation fabric provides an insurance policy against base failure.

CAN EP HENRY PAVERS BE USED FOR MY DRIVEWAY?

Absolutely! For residential driveways, 10"-12" of compacted dense graded aggregated base material is recommended. A standard 2 3/8" thick paver can be used for light vehicular (cars and pickup trucks) applications. A Herringbone pattern

is most suitable in these situations. Contact your local EP Henry Authorized Distributor® or EP Henry’s Technical Manager for questions on choosing the appropriate paver.

TELL ME ABOUT THE SAND SETTING BED. Do not use stone dust or screenings; they do not allow the pavers to “seat” properly and do not allow for drainage.

The sand should be an even 1" thick layer. Do not compact the sand setting bed. Do not mix portland cement into the sand used for the setting bed or the joints between pavers. It defeats the flexibility of the system, and it cannot be cleaned off the surface of the pavers.

HOW DO PAVERS COMPARE WITH PATTERNED OR STAMPED CONCRETE?

Patterned concrete pavements are merely slabs of concrete that are embossed with a pattern. Therefore, they are prone to the same problems with freeze-thaw cycles, namely cracking. We guarantee that EP Henry Pavers won’t crack; you cannot obtain a similar guarantee for stamped concrete. Stamped concrete requires expansion joints every 10 feet or so, which are very distracting in some patterns. Also, unlike EP Henry Pavers, patterned concrete pavements don’t allow access to underground utilities or the ability to make repairs. At virtually the same price per square foot installed, EP Henry Pavers are clearly a superior choice.

WHAT ARE THE ADVANTAGES OF SEALING MY PAVERS?

Depending upon the sealers, they can offer three advantages: they help resist stains, enhance the color, and bind the sand in the joints to make it difficult for weeds to germinate. Sealers, however, are topical products and must be reapplied regularly (generally every 3-5 years). Sealers maybe water-based or solvent-based as long as they are low VOC and compliant with government regulations.

WILL WEEDS GROW BETWEEN MY PAVERS?

Weeds and grass result from seeds or spores blowing into, and lodging in, the joint sand. This can be minimized by using a Techni-Seal polymeric sand or by sealing the pavers with a joint stabilizing sealer or mixing a pre emergent granular weedkiller in the joint sand. If weeds do appear, a spot vegetation killer (such as Round-Up™) can be used and will not damage the pavers.

WHAT CAN I DO IF MY PAVERS ARE STAINED OR DAMAGED?

One of the advantages of pavers is that individual units can be removed and replaced in these situations. Remove the sand around the paver and then use two flat head screwdrivers to lift the paver out. Rocking the paver gently in a back-and-forth motion will facilitate removal.

HOW ABOUT USING EP HENRY PAVERS ON MY POOL DECK?

Not only do EP Henry Pavers make an attractive pool deck, but they also provide a slip-resistant walking surface. Pavers actually are better than poured concrete around pools from the standpoint that the joints will take on moisture and leave the pavement cooler under foot. Like all products that are used outdoors, lighter colors will tend to stay cooler as they reflect the sunlight. Furthermore, our Bullnose Pavers make a nice pool coping.

Make sure the base material around the pool is well compacted before installing pavers. Safety covers can also be installed over pavers with the use of special anchors.

CAN I USE DE-ICING SALTS ON MY PAVERS?

Yes, you can. EP Henry Pavers have a greater resistance to de-icing salts than conventional paving materials due to their high cement content, strength, density, and low absorption. By definition, paving stones meeting ASTM C-936 — the standard specification for unit concrete pavers — are considered de-icing salt resistant. EP Henry Pavers exceed the requirements of ASTM C-936. Do not be misled by claims of pavers being guaranteed against de-icing salts. **There is no concrete product that is immune to the long term effects of de-icing salts.**

I HAVE AN EXISTING CONCRETE WALKWAY THAT'S IN PRETTY GOOD SHAPE. CAN I LAY PAVERS OVER IT?

While not the preferred method, pavers can be laid on top of existing concrete walkways. Two issues must be addressed. First, the grade will be raised by about 3" (the thickness of the pavers plus the bedding sand). This is particularly critical if any doorways are involved. Second, if the existing concrete slab should raise or drop with freeze/thaw conditions, then the pavers will do the same.

HOW CAN I REMOVE MOSS OR MOLD FROM MY PAVERS?

Try Clorox® diluted in water (10 parts water to one part Clorox). Be careful not to get it on other plant material. Keep in mind that there is nothing that will keep it from growing back if it’s in a shady, damp area. For a more permanent solution, you will need to correct the moisture and shade problems that are encouraging the moss or mold.

WHAT IS THE WHITISH DEPOSIT I SEE ON SOME PAVEMENT INSTALLATIONS?

You are probably referring to efflorescence, a natural and common occurrence in concrete and brick products. Efflorescence is the result of natural salts in the materials used in production migrating to the surface of the pavers. This is not a defect nor harmful to the pavers, and will usually weather away with time. Although it is best to allow a year or more for efflorescence to weather away, if you don’t want to wait for it to weather away, Techni-Seal® offers an excellent cleaning product to remove it. Do not use efflorescence cleaners repeatedly. Once the pavers are cleaned, it is recommended that they be sealed.

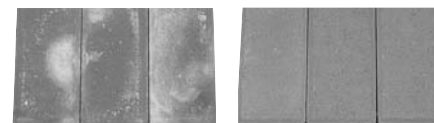

PAVERS WITH EFFLORESCENCE

CLEANED PAVERS

EP Henry offers an extensive library of technical and construction information at [ephentry.com/technical](http://www.ephentry.com/technical)

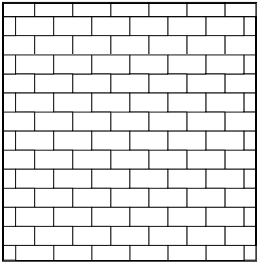

RUNNING BOND

100% All Styles
 Coventry® Stone I and Old Towne Cobble™
 Any combination of sizes, same direction
 Coventry® Stone II (4 sizes in cube)
 Coventry® Stone III (3 sizes in cube)
 Coventry® Stone IV
 ECO Cobble®
 Village Square® 6"x6" or 12"x12"
 6"x12" Half Village Square
 Brick Stone, Coventry® Brick Stone, Historic
 Brick Stone
 ECO™ Paver
 Danbury

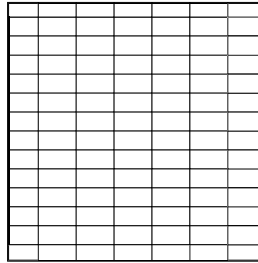

STACKED BOND

100% All Styles
 Coventry Stone I and
 Old Towne Cobble 6"x6" or 6"x9"
 Village Square® 6"x6" or 12"x12"
 6"x12" Half Village Square
 Brick Stone, Coventry Brick Stone,
 Historic Brick Stone
 Coventry Stone IV
 Danbury

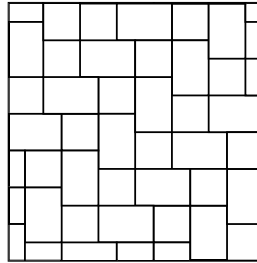

MODIFIED HERRINGBONE

Coventry Stone I and ECO Cobble®
 Old Towne Cobble 60% 6"x9", 40% 6"x6"

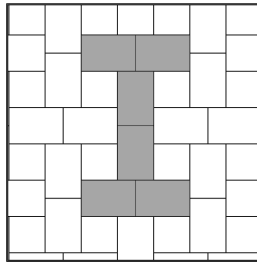

"1"
 Coventry® Stone I, ECO Cobble® and
 Old Towne Cobble™ 70% 6"x9", 30% 6"x6"

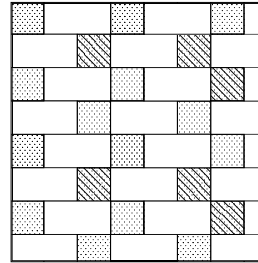

SEWINDER

Village Square
 69% 6"x12", 31% 6"x6" VS

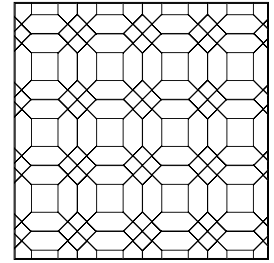

VENETIAN PARQUET

Symetry
 83% Symetry, 17% Symetry Squares

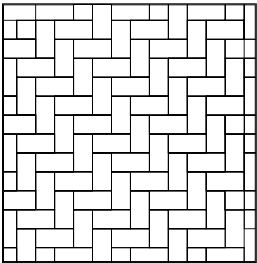

90° HERRINGBONE

100% All Styles
 Coventry Stone IV
 ECO Cobble®
 Village Square® 6"x6" or 12"x12"
 6"x12" Half Village Square
 Brick Stone, Coventry Brick Stone,
 Historic Brick Stone
 Danbury

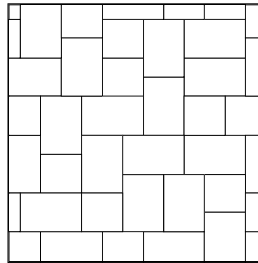

RANDOM

60% 6"x9", 40% 6"x6"
 Old Towne Cobble, Coventry Stone I and
 ECO Cobble®
100% All Styles in Cube
 Coventry Stone III
 Bristol Stone
 Chiseled Stone

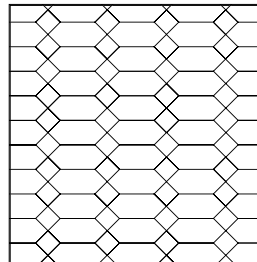

DIAMOND RUN

100% Symetry®

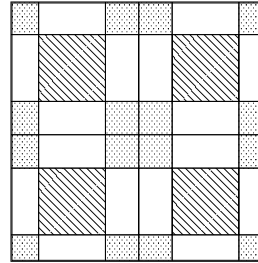

CHECKERS

Village Square
 25% 12"x12" VS, 50% 6"x12" HVS,
 25% 6"x6" VS

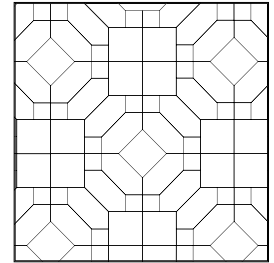

GRAND PARQUET

Symetry
 66% Symetry, 34% Symetry Squares

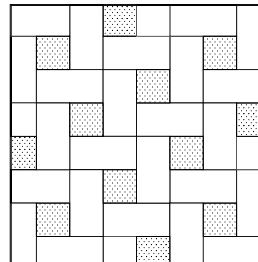

PINWHEEL

Village Square
 81% 6"x12" HVS, 19% 6"x6" VS

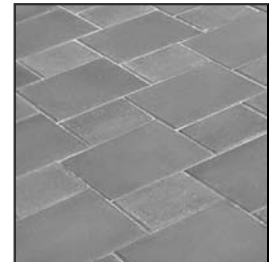

CREATE YOUR OWN

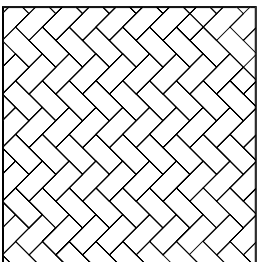

45° HERRINGBONE

100% All Styles
 Coventry Stone IV
 Brick Stone, Coventry Brick Stone,
 Historic Brick Stone
 6"x12" Half Village Square
 Danbury

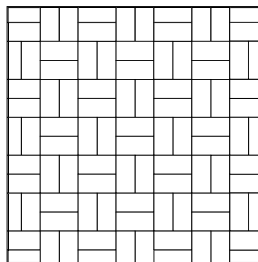

BASKETWEAVE

100% All Styles
 6"x12" Half Village Square®
 Brick Stone, Coventry Brick Stone,
 Historic Brick Stone
 Danbury

Border Patterns

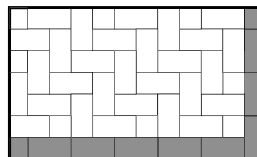

SAILOR BORDER

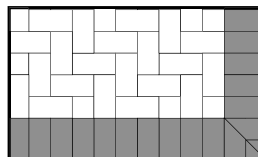

SOLDIER MITRED CORNER

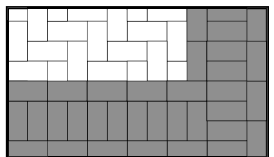

SAILOR/SOLDIER/SAILOR

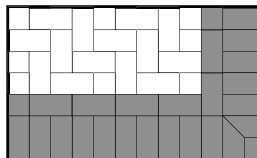

SOLDIER MITRED CORNER/SAILOR

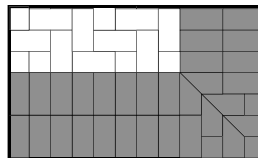

DOUBLE SOLDIER MITRED CORNER

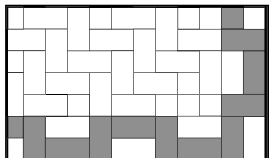

ZIG ZAG

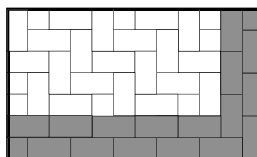

DOUBLE SAILOR HALF RUNNING BOND



CREATE YOUR OWN



CREATE YOUR OWN

Please refer to the current year catalog for a complete list of products available.

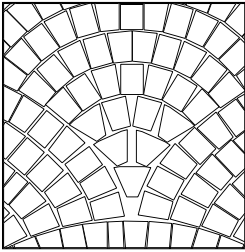

FANS

Coventry Stone I and Old Towne Cobble
One circle pallet = 3 fans

Note: The first course centerstone must be hand-cut from a 6"x9" unit.

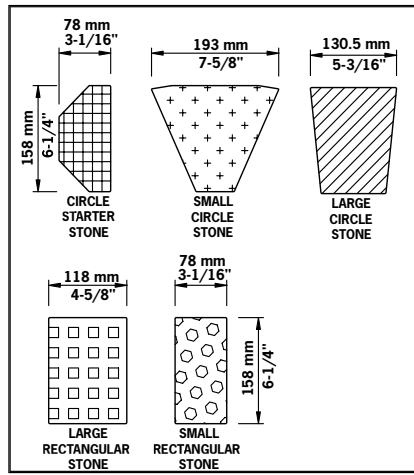

Old Towne Cobble™ & Coventry® Stone I Circle Kit

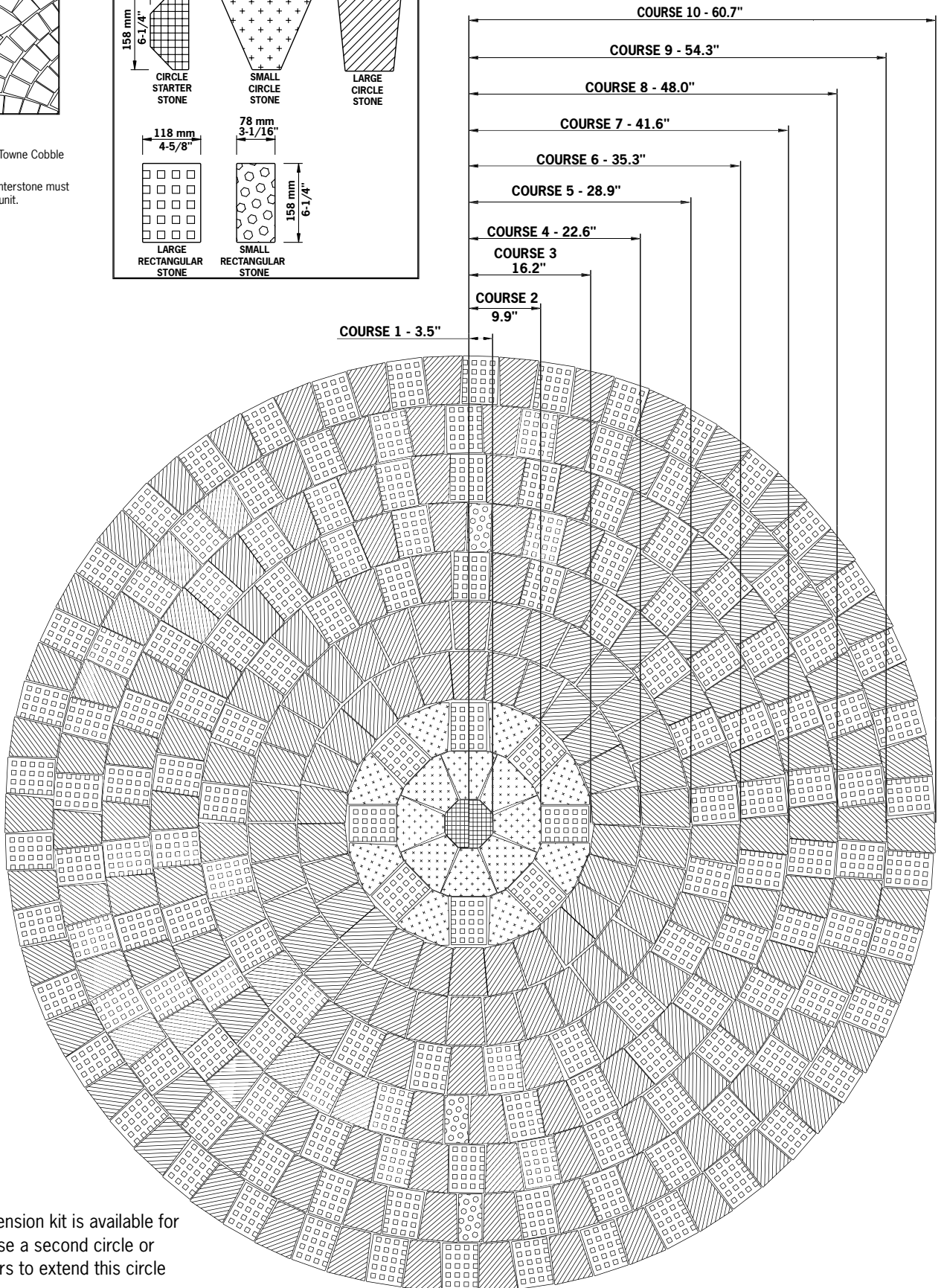

Note: No extension kit is available for this pattern; use a second circle or standard pavers to extend this circle



Installation Details

Before undertaking a permeable pavement installation, it's important to choose the construction detail that's appropriate for your soil type and design requirements.

Determining the on-site underlying soil type (clay, silt, sand) is the first step in choosing the construction detail that's appropriate for your project. Although the surface infiltration rates of EP Henry's ECO Line of permeable pavers are extremely high, the infiltration rates of the underlying soils determine how quickly captured water will infiltrate into the ground.

Ideally, the quantity of water that enters a permeable paver system should infiltrate/exfiltrate your permeable paver system within 24-48 hours. However, it's possible that your underlying soils can not absorb water rapidly enough due to the composition of the soil. In cases where your soil cannot absorb the water received in a given precipitation event within 24-48 hours, conveyance movement via drainage pipes to additional storage or infiltration areas may be appropriate.

In basic terms, clay can absorb the least amount of water, and sand can absorb the most. It is important to note that when using the Partial or No Infiltration construction details, a drainage pipe is specified which must have positive flow away from the aggregate base. This drainage pipe can be directed to auxiliary on-site infiltration trenches, rain gardens, bio-swales, detention basins, or nearby storm pipes. Municipal approval is required for any stormwater "tie-ins."

Definitions

Infiltration: The penetration of water through the ground surface into the subsoil

Exfiltration: Loss of water from a drainage/permeable pavement system into the surrounding soil

Note: The following represent several common details for EP Henry's line of permeable pavers.

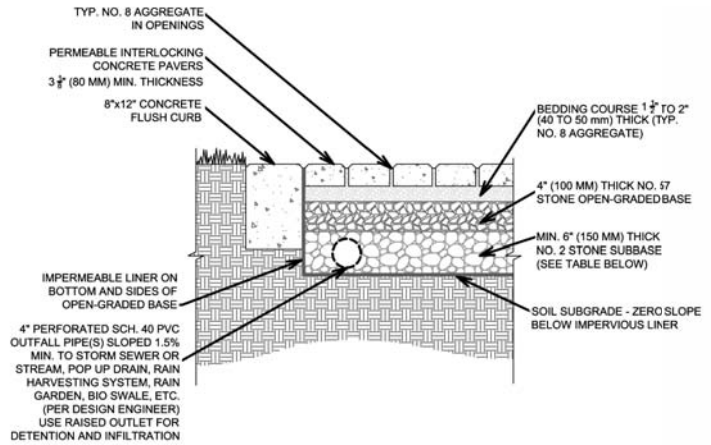

NO INFILTRATION

If your soils have high clay content, you are constructing over bedrock, a high water table, or environmental hot spots, the No Infiltration option is appropriate.

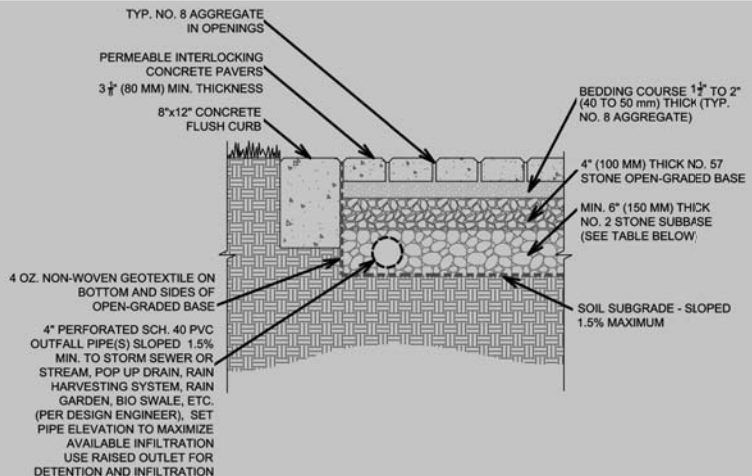

PARTIAL INFILTRATION

If your soils are of medium texture, with roughly equal portions of sand, silt, and a little less clay, the Partial Infiltration construction detail would be appropriate.

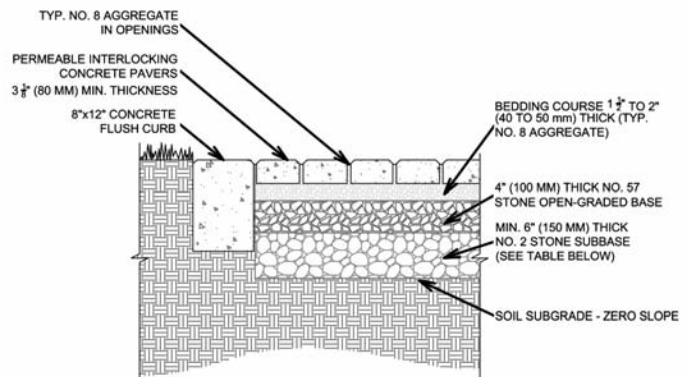

FULL INFILTRATION

If your soils are very sandy, with no clay and very few fine particles, the Full Infiltration construction detail would be appropriate.

Note: 2 3/8" (60MM) thick pavers may be used in pedestrian applications. No. 2 stone subbase thickness varies with design. Consult ICPI's permeable interlocking concrete pavement manual for charts.

For more information, details, and LEED information, please visit ephenryecocenter.com.

HOW IS INSTALLING DEVONSTONE DIFFERENT FROM PAVERS?

DevonStone requires 1-3/8" low profile edge restraint suitable for its thinner profile, not standard height edge restraint. Plate compactors may not be used on DevonStone, instead use a dead blow hammer or a long block of wood that can be placed over the DevonStone unit and struck with a hammer to seat the units in the setting bed. Uniform spacing for Saw Cut DevonStone can be achieved with tile nips.

MY DEVONSTONE SLABS HAVE A WHITE HAZE ON THEM. WHAT IS IT?

You are probably referring to efflorescence, a natural and common occurrence in concrete and brick products. Efflorescence is the result of natural salts in the materials used in product migrating to the surface of the slabs.

This is not a defect nor harmful to the slabs and will usually weather away with time.

HOW DO I CUT DEVONSTONE?

DevonStone can be easily cut with any power saw with a diamond blade. Always wear protective glasses and a mask when cutting with a power saw. If using water during the cutting process, be sure to immediately clean and residue that may be left on the stone or staining may result. Do not use a hammer or chisel to cut DevonStone.

CAN I USE DEVONSTONE ON MY DRIVEWAY?

No. DevonStone is not suitable for any vehicular traffic.

CAN I USE DEVONSTONE INSIDE?

Absolutely, just install it the same way you would tile, with a thinset adhesive.

CAN I USE DEVONSTONE WITH MY EP HENRY PAVERS?

Yes you can, but you must account for the difference in thickness. Most pavers are 2 3/8" or 3 1/8" thick; DevonStone is 1 5/8" thick. Do not attempt to compensate for the variability in thickness with the bedding material.

Important Notes:

DO NOT use a plate compactor on DevonStone.

It is recommended if you choose to seal DevonStone slabs, use only Techni-Seal Sealant for Wet Cast Pavers.



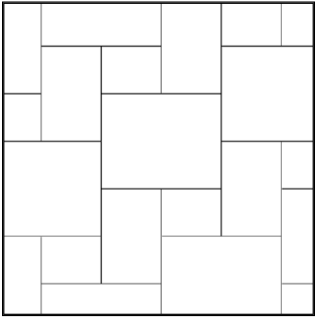

TUDOR

Saw Cut

14% 12"x12", 29% 12"x24"
57% 24"x24"

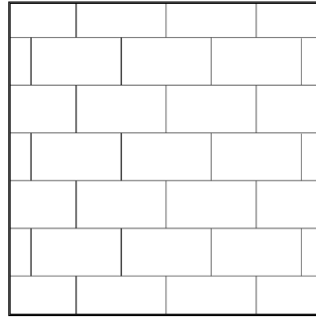

RUNNING BOND

Saw Cut

100% 12"x18", 12"x24"
or 18"x24"

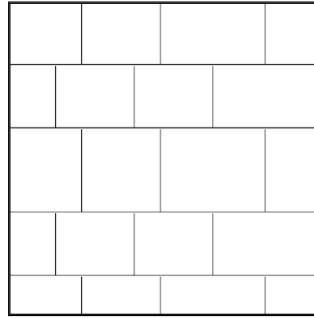

RUNNING BOND WITH 3 SIZES

Saw Cut

30% 18"x18", 34% 18"x24",
36% 24"x24"

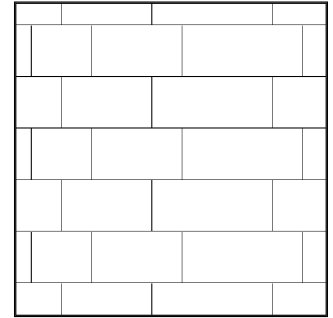

RUNNING BOND WITH 3 SIZES

Saw Cut

28% 12"x12", 34% 12"x18",
38% 12"x24"

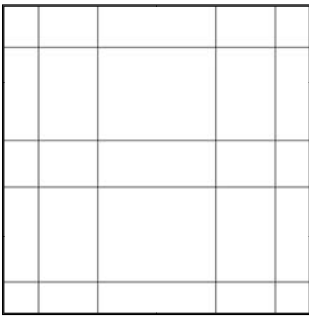

TARTAN PLAID

Saw Cut

17% 12"x12", 49% 12"x24",
34% 24"x24"

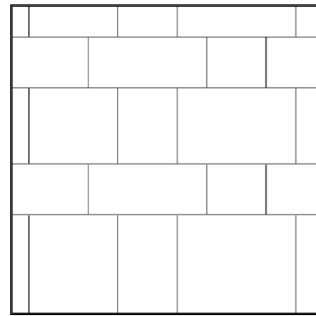

RUNNING BOND

Saw Cut

100% 12"x18", 18"x24" or 12"x24"

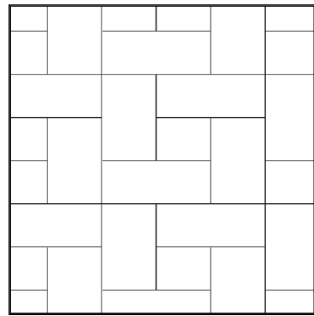

TILE

Saw Cut

12% 12"x12", 88% 12"x24"

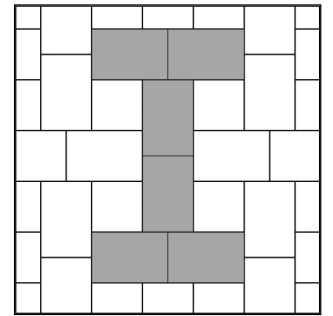

"I" PATTERN

Saw Cut

31% 12"x12", 69% 12"x18"

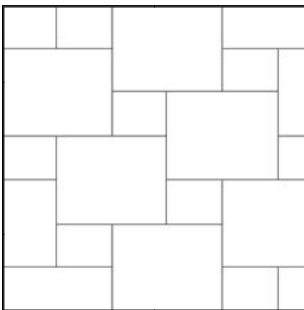

HOLLAND DUTCH

Saw Cut

21% 12"x12", 79% 24"x24"

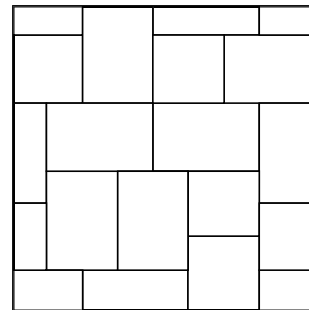

RANDOM

Saw Cut

10% 12"x12", 21% 12"x18",
14% 18"x18", 10% 12"x24",
30% 18"x24", 15% 24"x24"

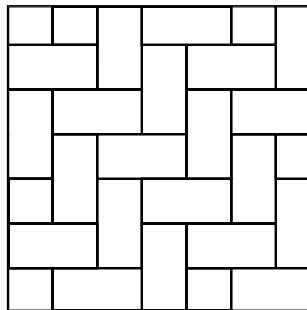

90° HERRINGBONE

Saw Cut

100% 12"x18"

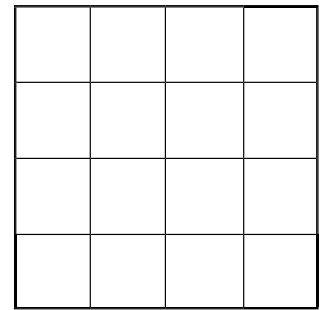

STACKED BOND

Saw Cut

100% 18"x18" or 100% 24"x24"

Installation Types



GRAVEL OR SAND INSTALLATION ONTO GROUND
(Pedestrian Foot Traffic)

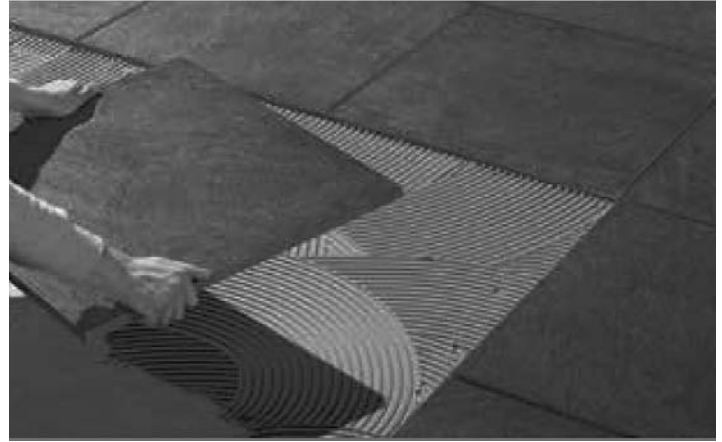

CEMENTITIOUS ADHESIVE INSTALLATION ONTO CONCRETE BASE
(Vehicle Traffic)

Precautions To Be Taken Before Any Form of Installation

- When lifting product always use assistance, and proper lifting techniques.
- Always call before you dig. It is important to contact all telecommunication and utility companies, in order to mark existing cables and pipes before excavation.
- Always read instruction manual for any equipment before use, and adhere to all safety instructions.
- Always use proper safety equipment when installing LASTRA 20mm slabs: e.g. gloves, safety goggles, knee pads, and hearing protection.
- Always slope paved surface at least 2% away from buildings or foundations.
- Never use a plate compactor on LASTRA 20mm slabs.



When lifting product always use assistance, and proper lifting techniques.

CLEANING AND MAINTENANCE

- Cleaning and maintenance procedures can be carried out using a common neutral detergent and a garden hose. A pressure washer is fine for use. Be sure to use it on the mild setting so that the polymeric sand or joint material is not disturbed. Inclined surfaces and the presence of open joints between slabs allows for the collection of dirt near the discharge points.
- Please note that because of surface tension in liquids, a film of water can form on any outdoor surface even when inclined properly. To avoid a film of water on the surface of the material it is important to completely dry the surface; push the water towards joints using a scrubbing-brush or use a wet and dry vacuum cleaner.
- When cleaning the surface of the paving slabs be sure to use a brush or broom with soft nylon bristles.

Gravel or Sand Onto Ground

(See diagram below)

EXCAVATION

- Always call 811 before you dig. It is important to notify all telecommunication and utility companies in order to mark existing cables and pipes before any excavation.
- When digging make sure to dig a depth that will include the entire base. The depth of the base will be determined by preexisting soil and climate conditions in your area.
 - Take into account that a clay or silt soil will require a deeper sub base (6"-8") (16-20cm)
 - For a sand or gravel soil (4"-6") (10-16cm) should suffice.

SOIL COMPACTION

- Compact the soil ensuring a minimum of 2% slope away from buildings and foundations. This will increase the load bearing strength of the soil, and minimize movement due to freezing or thawing and other seasonal changes.
- Soil must be compacted to 98% standard proctor density for pedestrian traffic.

Preliminary Information

TILE CUTTING LASTRA 20MM

- Due to the thickness and natural hardness of porcelain, LASTRA 20mm slabs require a wet saw with at least 1.5 HP, and a 10" or 8" (20-25cm) diamond blade. Take into consideration the length of cut when choosing the appropriate saw for different sized LASTRA 20mm products. The length of cut should be at least 24" (60cm), or 38" (96cm) for diagonal cuts for LASTRA 20mm 24"x24" (60x60cm).
- Be aware that all cut porcelain edges will be very sharp; handle with care.

Lastra 20mm

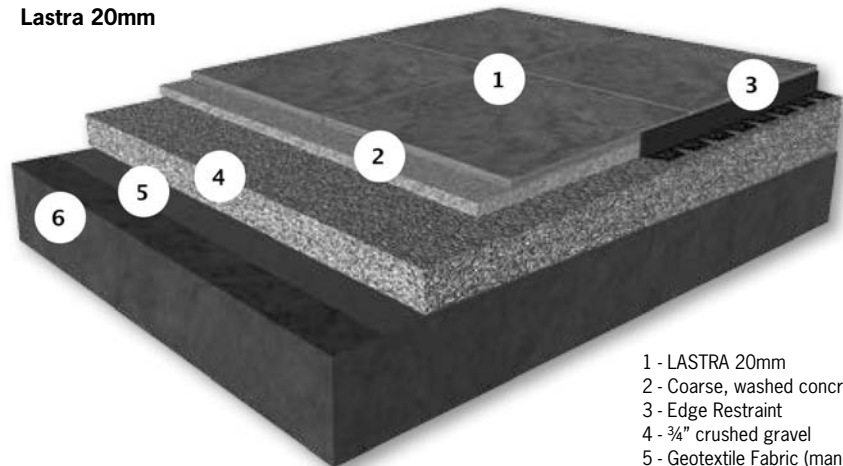

- 1 - LASTRA 20mm
- 2 - Coarse, washed concrete sand
- 3 - Edge Restraint
- 4 - ¾" crushed gravel
- 5 - Geotextile Fabric (mandatory)
- 6 - Soil

GEOTEXTILE INSTALL AND SUB-BASE

- DO NOT USE CRUSHED CONCRETE FOR YOUR BASE.
- Cover the top and the sides of the excavated area with a geotextile fabric to prevent the dispersions of the substrate, and to allow for drainage. Select the geotextile according to project specification, and the recommendations of the geotextile producer.
- Prepare a sub-base made up of 0-3/4" (0-2cm) crushed stone to allow for drainage and stability. It should be installed in 4"-6" (10-16cm) lifts, and compacted with at least a 5,000-7,000 lb. vibrating plate compactor and levelled off.
- Cover the top of the prepared sub-base with geotextile fabric also according to project specification, and the recommendations of the geotextile producer. This will increase the stability and the longevity of the installation.

EDGE RESTRAINT

- Install edge restraints according to project specifications, and the recommendations of the restraint producer. This will help reduce horizontal creeping, and the loss of sand or gravel.
- Take into account the depth of the setting bed and the height of the paving slab when choosing an appropriate edge restraint.

PREPARATION OF SETTING BED

- FOR PAVER SLABS SET ON A GRAVEL BED (RECOMMENDED METHOD)
Fill with coarse washed concrete sand (ASTM C33) to a depth of 2" (5cm). COMPACT THE SETTING BED WITH A VIBRATING PLATE COMPACTOR AND LEVEL OFF WITH A MINIMUM INCLINATION OF 2%.
- FOR PAVER SLABS SET ON A SAND BED
Lay 2" (5cm) thick pipe (screed rails) parallel every couple of feet. Fill with 2" (5cm) of paver sand, and pass flat board over screed rails to level out sand base. Remove screed rails and fill gaps with paver sand, and level. Gently mist, and compact using a vibrating plate compactor. Be sure to allow for at least a 2% slope for drainage in the appropriate direction.



▲ Preparing the setting bed



▲ Compacting

INSTALLATION OF SLABS

- Select size and color of the pavers and install them on the prepared surface. Complete the laying scheme according to the project specifications or to your preferences.
- To achieve a more natural look randomly select pavers from different boxes. This will maximize the effect of shade variation on the installed surface, WHICH IS THE DESIRED EFFECT OF LASTRA PORCELAIN SLABS.
- Always leave a joint between the slabs of at least 5/32" (4mm), while using proper plastic spacers (pictured below). This will avoid porcelain to porcelain contact.

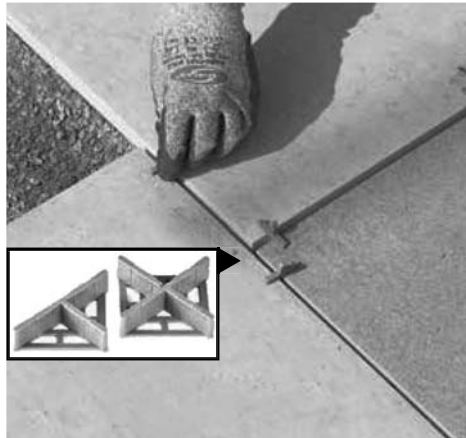

▲ Spacers

Lastra 20mm

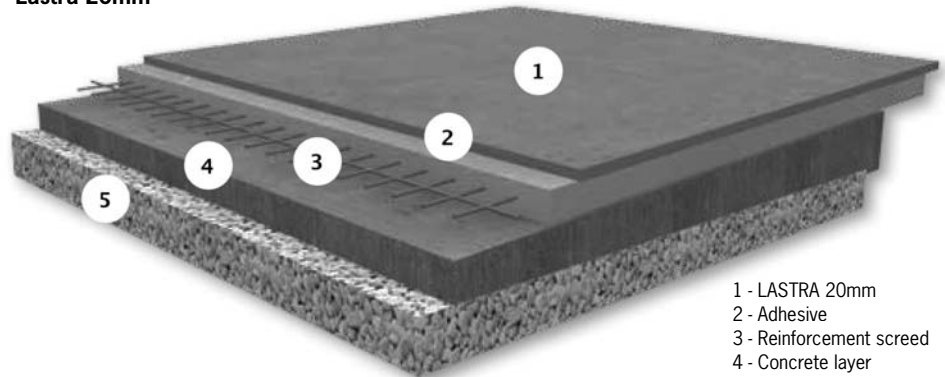

- 1 - LASTRA 20mm
- 2 - Adhesive
- 3 - Reinforcement screed
- 4 - Concrete layer
- 5 - Gravel layer

FILLING THE JOINTS

- Polymeric sand should be installed according to the instructions provided by the producer.
- Never use a vibrating plate compactor on the paved surface, instead use a rubber/PVC mallet to help adhere the pavers to the support.



▲ Sweeping sand in the joints

Cementitious Adhesive Installation onto Concrete Base (See diagram below)

INSTALLATION OF PAVERS

- Concrete base must meet all building code requirements for installation area, and must have a slope of 2% away from any buildings or foundations.
- Do not install pavers directly over control joint on the concrete base. Otherwise expansion and contraction of the control joint due to freezing and thawing could damage the pavers.
- Install the pavers with the double spreading method while using highly deformable cement-based.

JOINTS

Place the pavers leaving a joint of at least 5mm between each one using cement-based premium mortars (class CG2 in compliance with ISO 13007).

Coventry® Wall and Tudor Wall™

Tools: Shovel, wheelbarrow, level, string line, hammer, tape measure, wooden stakes, dead blow hammer, plate compactor, and splitter for splitting block.

CALCULATE WALL MATERIALS NEEDED

Coventry Wall and Tudor Wall are sold by the square foot. Determine the square footage of wall block needed by multiplying the wall's length by its height (don't forget that you'll need to bury a portion of the wall — see "Prepare the Footing"). Both the 3' high and 6' high pallets contain 50 sf wall block. Due to the walls' modular height, both heights can be combined within the same wall. To calculate the number of pins needed, subtract one from the number of non-cap courses and multiply that result by the total lineal feet of wall. For example, for a 20' long wall, five courses high plus a cap, you would need $(5-1) \times 20 = 80$ pins. To calculate the number of caps needed, divide the total lineal feet of wall by 1.33 ($20' \text{ long wall} \div 1.33 = 15 \text{ caps}$) for the 16" long rectangular cap.

PREPARE THE FOOTING

Dig a trench 24" wide and a minimum of 12" below grade depending on the overall height of the wall. As a rule of thumb, you will bury 10 percent of the wall height or a minimum of 6", whichever is greater. Make sure the soil at the bottom of the trench is well compacted to prevent settling. In heavy or clay soils for best results, wrap the footer trench in a "U" shape configuration with geotextile. This will preserve the stone base over time and keep it from migrating into the clay soil. Using a vibratory plate compactor, install 6" of modified stone in two 3" layers making sure the surface of the last layer is smooth and level.

Tip: Add a 1" layer of sand or stone screenings on top of the footing to make the base course easier to level.

INSTALL THE BASE COURSE*

Install the first layer of the walls by placing the units, narrowest slot ($\frac{1}{2}$ " wide) on the top of the block and towards the back, on the prepared base. For a battered wall (where each course sets back), level the units with a carpenter's level from front to back and side-to-side. For non-battered walls, level the units from side-to-side, but tilt the bottom block slightly back so that the entire wall, when constructed, leans slightly towards the soil being retained. Check for straightness by using a string line on top of the block, using the slot as a guide. Each pallet of the walls comes with five different length stones; use a combination of sizes.

Note: EP Henry offers Base Course Block and Torpedo Base Block which facilitate ease of installation and provide improved structural stability.

Note: Structurally, battered walls are superior to non-battered walls.

INSERT THE PINS

Insert one pin, as shown, in each block except the 4" long unit. Adhesive should be used to hold the 4" units in place. The 16" units may require the use of two pins. Note that pin placement for battered walls is different than that for non-battered walls (see diagram at far right).

BACKFILL THE WALL

Backfill 12" behind each layer of the wall with well-draining granular fill #57 (1-1/4", 3/4" and 1/2") or #67 (3/4") clean stone. All soil behind the wall must be compacted. Use only lightweight mechanical compaction equipment within 3' of the back of the units.

Tip: Consider using a geotextile landscape fabric directly behind the wall block to prevent fine soil particles from washing through to the front. Also consider overlaying the drainage stone behind the wall with geotextile to prevent covering soil or mulch from clogging the drainage stone.

INSTALLING ADDITIONAL COURSES

Place the next and additional courses of the wall in a staggered or half bond fashion, randomly using all sizes. Avoid having a vertical line span more than two layers of block. Insert pins in each course as you build the wall, making sure that every pin is oriented the same way. Backfill each course as the wall is being built. For building combination walls that use both the 3' and 6' high units, the ratio depends on your personal taste. Generally, a combination wall will be 70 percent 6" units and 30 percent 3" units. Special note on 3"-6" combination walls with a set-back: When laying two courses of 3" block, it is important that you only batter one of them; this will help keep the set-back in line with your 6" courses. Maximum unreinforced height for the walls is 24' for non-battered walls and 36" for walls built with a set-back, under ideal conditions.

CAP THE WALL

Attach the wall cap blocks with a high strength, flexible concrete adhesive. An overhang of 1" in the front looks best. Some cutting may be necessary; consult your EP Henry Authorized Hardscaping Distributor® for cutting equipment suggestions.

ADDITIONAL TIPS:

BUILDING 90° CORNERS

Special units are available to construct true 90° corners. They are 14" long and available in both 3" and 6" heights. To build 90° corners, begin construction at the corner of the wall and work outward. Alternate the long dimension of corner units to maintain a running bond pattern. Use a high strength flexible adhesive to bond the corner blocks together, as there are no slots for pins. Also, any single battered wall with a 90° corner on each end requires cutting the corner units to accommodate the wall batter as the wall rises to maintain the running bond pattern.

STEPS

The installation of steps requires careful layout and planning. It is critical that the base be properly installed; see "Prepare the Footing" for details. A minimum of 6" of modified stone base is required under all risers. Check local construction codes for minimum riser height and tread depth. Use the wall blocks to create the riser and the 12"x3"x16" or Universal Caps for the tread. Bullnose Pavers may also be used for the tread.

When constructing steps, bury a block behind the visible riser. In other words, each step should be at least two blocks deep. This will give the tread (cap) more stability by allowing the front block of the upper step to bear on the back block of the lower step. Use a high strength concrete adhesive to attach the treads to the risers.



▲ This wall has been engineered due to its height

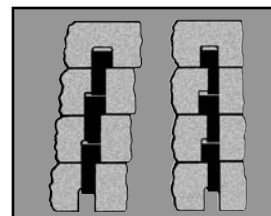

BATTER

For walls with a set-back, insert pin as shown above.

NO BATTER

For walls without a set-back, insert pin as shown above.

PIN

Please see page 22 for more information on EP Henry Base Course Block and Torpedo Base Block.

Note: These instructions are meant as a general guideline for walls under ideal conditions, and assuming no slopes or surcharges. Site-specific conditions may warrant additional installation requirements.

Caution: Dry sawing or grinding of concrete products may result in the release of respirable crystalline quartz. Prolonged exposure to respirable crystalline quartz may cause delayed (chronic) lung injury (silicosis). The use of a NIOSH-Approved respirator and tight-fitting goggles are recommended when sawing or grinding operations are in progress.

Coventry® Wall III

Tools: Shovel, wheelbarrow, level, string line, hammer, tape measure, wooden stakes, dead blow hammer, plate compactor, and splitter for splitting block.

GENERAL GUIDELINES

- Maximum height for Coventry Wall III in freestanding applications without engineering assistance is 33" (exposed height including cap)
- Seek a qualified professional engineer where a taller wall may be required.
- Curves in the wall, corners, and piers will all help with the stability of your Coventry Wall III.
- Both pins and adhesive are required for proper installation of a Free Standing Coventry Wall III.
- Seat walls are typically 18"- 24" high, parapet walls are typically 30"- 33" high.

CALCULATE MATERIAL NEEDED

Coventry Wall III is sold by the square foot. Determine the total square feet of wall needed by multiplying the length times the height (don't forget the block that will be below grade). Both the 3" high pallet and 6" high pallet contains 40 square feet of wall block. Due to the modular sizes of Coventry Wall III, both heights can be combined within the same wall. Use the following formula to calculate the number of pins needed:

(Number of non-cap courses – 4) x linear feet of the wall x number of pins per linear foot (2.3) = total number of pins.

A 20' long wall, 5 courses high (without caps) 5-1 = 4'x20' = 80, 80 x 2.3 = 184 pins needed.

Use the following formula to calculate the number of Universal Caps needed:

Total lineal feet ÷ 1.25

= total number of Universal Caps needed

Example: A 20' long wall = 20' ÷ 1.25

= 16 Universal Caps needed

Note: Coventry Wall III pins are required for this wall system and cannot be substituted by standard Coventry Wall pins which are significantly smaller.

PREPARE THE FOOTING

Dig a trench 24" wide and a minimum of 12" below grade depending on the overall height of the wall. As a rule of thumb, you will bury 10 percent of the wall height or a minimum of 6", whichever is greater. Make sure the soil at the bottom of the trench is well compacted to prevent settling. In heavy or clay soils for best results, wrap the footer trench in a "U" shape configuration with geotextile. This will preserve the stone base over time and keep it from migrating into the clay soil. Using a vibratory plate compactor install 6" of modified stone in two 3" layers making sure the surface of last layer is smooth and level.

Tip: Add a 1" layer of sand or stone screenings on top of the compacted stone in the footing to make the base course easier to level.

INSTALL THE BASE COURSE*

Install the first layer of Coventry Wall III by placing the units with the parallel channel grooves facing up and the flat side on the prepared base. Screenings or coarse concrete sand may be used as a leveling agent, but should not exceed 1" in depth. It is recommended that EP Henry Base Course Block* or 6" units be used for the first course to help ensure the wall's stability. Level the units from front to back and side-to-side using a dead blow hammer and level. Coventry Wall III blocks come in 3 different lengths. Align the base course with a string line to assure a straight wall where applicable.

Note: EP Henry offers Base Course Block, and Torpedo Base Block, which facilitates ease of installation and provides improved structural stability. When using the Base Course Block glue the first course of Coventry Wall III to the Base Course Block to maintain structural stability.

INSTALLING ADDITIONAL COURSES

Place the next and additional courses of Coventry® Wall III in such a fashion that each block bridges two units below in a running bond pattern, wherever possible. Avoid having a vertical line span more than two layers, or 6" of block. Lay additional courses starting at the corner and working toward the center. Insert two pins in the bottom of each block in each course as you build the wall, making sure that the square portion of every pin is seated in the receiving channel of the block below. The pins may be placed diagonally or so they seat into only one channel keeping the other channel clear for electrical wiring. Marry the angles of the blocks to avoid gaps and to keep the continuity of the rock face on both sides of the wall. The tightest radius possible using only the 10" and 6" long units is 33.5" to the back of the blocks. By using the 16" long blocks and with the smaller units you can achieve a larger radius. It is necessary to run a bead of high strength, flexible concrete adhesive on the outside edge of both channels about 1"- 2" from both of the faces of the block, between each course for structural stability.

INSERT THE PINS

Insert pins so the cylindrical end is placed into the round opening on the flat side of the Coventry Wall III block. The square end of the pin should protrude from the flat side of the block to allow it to fit into the receiving channel in the blocks below. Note: the pin placement for battered walls is different than that for non-battered walls. For free standing and non-battered walls the pins should be placed with the square end oriented toward the center of the block. For battered retaining wall construction the square end of the pins should be placed oriented toward the front of the block. When properly set and aligned, this will result in a 1/2" batter (set back) of the block.

Please Note: Use a dab of high strength flexible concrete adhesive in place of a pin/connector at any location in the wall where a splittable stretcher (without channels completely across the bottom of the block) prevents the use of a pin/connector.

Battered Alignment



Non Battered Alignment

BUILDING 90° CORNERS

Please note one 16" long unit on every layer of block per pallet is solid on one side with no channels to allow that unit to be split in the field as a corner. Standard Double Sided Coventry Wall corners are available in both 3" and 6" high units to readily create 90° corners as well. To build 90° corners, begin construction at the corner of the wall and work outward. Alternate corner units with the long dimension running perpendicular to that of the unit below it to maintain a running bond pattern. After splitting the corner, take a piece of block and rake the face of the fresh split to create the aged look. Start by laying the corner unit first and work your base course away from the corner unit. After installing and leveling your base course, start the second course again at the corner. All courses of block in free standing wall construction must be glued using only high strength, flexible concrete adhesive. When building a corner, make sure that the corner unit overlaps two blocks beneath.

CAP THE WALL

After installing your last course of wall block, attach the Universal Coventry Wall Caps with a high strength, flexible concrete adhesive. The cap units should be installed following the contour of the wall and with a 1/2" - 1" overhang on both sides. Universal Coventry Wall Caps will fit a 6' 6" inside radius with no cuts.

(A) Alternate the orientation of the long and short sides of the Coventry Universal Caps for a straight wall.

(B) For a curved wall, marry the angles of the cap to conform to the radius. Some cutting may be necessary.

RETAINING WALLS AND BATTERED WALL CONSTRUCTION

Note: Structurally, battered walls are superior to non-battered walls.

BACKFILL THE WALL

Backfill 12" behind each layer of Coventry Wall III with well-draining granular fill #57 (1-1/4", 3/4" and 1/2") or #67 (3/4") clean stone. All soil behind the wall must be compacted. Use only lightweight mechanical compaction equipment within 3' of the back of the units.

Tip: consider overlaying the top surface of the drainage stone behind the wall with geotextile to prevent covering soil or mulch from clogging the drainage stone.

INSTALLING ADDITIONAL COURSES

Place the next and additional courses of Coventry Wall III in a staggered or half bond fashion, randomly using all sizes. Avoid having a vertical line span more than two layers of block. Insert pins in each course as you build the wall, making sure that every pin is oriented the same way. Only two pins per block are necessary. Backfill each course as the wall is being built. For building combination walls that use both the 3" and 6" high units, the ratio depends on your personal taste. Generally, a combination wall will be 70 percent 6" units and 30 percent 3" units. Special note on 3"-6" combination walls with a set-back: When laying two courses of 3" block, it is important that you only batter one of them; this will help keep the set-back in line with your 6" courses. Maximum unreinforced height for Coventry Wall is 24" for non-battered walls and 36" for walls built with a set-back, under ideal conditions.

STEPS

The installation of steps requires careful layout and planning. It is critical that the base be properly installed; see "Prepare the Footing and Install the Base Course*" for details. A minimum of 6" of modified stone base is required under all risers. Check local construction codes for minimum riser height and tread depth. Use the wall blocks to create the riser and the Rectangular Wall Cap or Universal Caps for the tread. Bullnose Pavers may also be used for the tread. When constructing steps, bury a block behind the visible riser*. In other words, each step should be at least two blocks deep. This will give the tread (cap) more stability by allowing the front block of the upper step to bear on the back block of the lower step. Use a high strength concrete adhesive to attach the treads to the risers.

***Tip:** for the most stable construction use of the EP Henry Filler Block to core fill steps will provide strength and stability to the step construction. The filler block is compatible with all 6" and 8" tall units. For more details visit ephenry.com/technical.

Double Sided Coventry® Wall and Double Sided Tudor Wall™

Tools: Shovel, wheelbarrow, level, string line, hammer, tape measure, wooden stakes, dead blow hammer, plate compactor, and splitter for splitting block.

GENERAL GUIDELINES

- Maximum height for the walls in freestanding applications without engineering assistance is 33" (exposed height including cap). Seek a qualified professional engineer where a taller wall may be required.
- Curves in the wall, corners, and piers will all help with the stability of the walls.
- Both pins and adhesive are required for proper installation of the walls.
- Seat walls are typically 18"-24" high, parapet walls are typically 30"- 33" high.

CALCULATE MATERIAL NEEDED

Double Sided Coventry Wall and Double Sided Tudor Wall are sold by the square foot. Determine the total square feet of wall needed by multiplying the length times the height (don't forget the block that will be below grade). Both the 3" high pallet and 6" high pallet contain 40 square feet of wall block. Due to the walls' modularity, both heights can be combined within the same wall.

Use the following formula to calculate the number of pins needed:

$$(\text{Number of non-cap courses} - 1) \times \text{linear feet of wall} = \text{total number of pins.}$$

Example: A 20' long wall, 5 courses high (without cap) $5 - 1 = 4 \times 20' = 80$ pins needed

Use the following formula to calculate the number of Universal Caps needed:

$$\text{Total lineal feet} \div 1.25 = \text{total number of Universal Caps needed}$$

Example: A 20' long wall = $20' \div 1.25 = 16$ Universal Caps needed

PREPARE THE FOOTING

Dig a trench 24" wide and a minimum of 12" below grade depending on the overall height of the wall. As a rule of thumb, you will bury 10 percent of the wall height or a minimum of 6", whichever is greater. Make sure the soil at the bottom of the trench is well compacted to prevent settling. In heavy or clay soils for best results, wrap the footer trench in a "U" shape configuration with geotextile. This will preserve the stone base over time and keep it from migrating into the clay soil. Using a vibratory plate compactor install 6" of modified stone in two 3" layers making sure the surface of last layer is smooth and level.

Tip: Add a 1" layer of sand or stone screenings on top of the footing to make the base course easier to level.

INSTALL THE BASE COURSE*

Install the first layer of the walls by placing the units, narrowest slot (1/2" wide) on the top, on the prepared base. Depending on the radius you are trying to achieve, you may need to turn a block upside down to ease installation. Screenings or coarse concrete sand may be used as a leveling agent, but should not exceed 1" in depth. It is recommended that 6" units be used for the first course to help ensure the wall's stability. Level the units from front to back and side-to-side using a dead blow hammer and level.

The walls blocks come in five different sizes. Use 6"x16" for setting the first course. Align the base course to a string line to assure a straight wall where applicable.

Note: EP Henry offers Base Course Block which facilitates ease of installation and provides improved structural stability.

INSTALLING ADDITIONAL COURSES

Place the next and additional courses of the wall in such a fashion that each block bridges two units below in a running bond pattern, wherever possible. Avoid having a vertical line span more than two layers, or 6" of block. Lay additional courses starting at the corner and working toward the center.

Insert pins in each course as you build the wall, making sure that the flag of every pin is oriented toward the wider part of the block.

Marry the angles of the blocks to avoid gaps and to keep the continuity of the rock face on both sides of the wall. The tightest radius possible using all sized units is 42". By using more of the smaller block and less of the larger units you can achieve a tighter radius.

It is necessary to run a bead of high strength, flexible concrete adhesive on both sides of the slot about 1"-2" from both of the faces of the block, between each course for structural stability.

BUILDING 90° CORNERS

Double sided corners are available in both 3" and 6" high units to readily create 90° corners. To build 90° corners, begin construction at the corner of the wall and work outward. Alternate corner units to maintain a running bond pattern. Use a high strength flexible adhesive to bond the corners together, as there are no slots for pins.

After splitting the corner, take a piece of block and rake the face of the fresh split to create the aged look.

Start by laying the corner unit first and work your base course away from the corner unit. After installing and leveling your base course, start the second course again at the corner. No pins will be used in the corner; use high strength, flexible concrete adhesive only. When building a corner, make sure that the corner unit overlaps two blocks beneath.

CAP THE WALL

After installing your last course of wall block, attach the Universal Coventry Wall Caps with a high strength, flexible concrete adhesive. The cap units should be installed following the contour

of the wall and with a 1/2" - 1" overhang on both sides. Universal Coventry Wall Caps will fit a 6' 6" inside radius with no cuts.

(A) Alternate Coventry Universal Caps for a straight wall.

(B) For a curved wall, marry the angles of the cap to conform to the radius. Some cutting may be necessary.

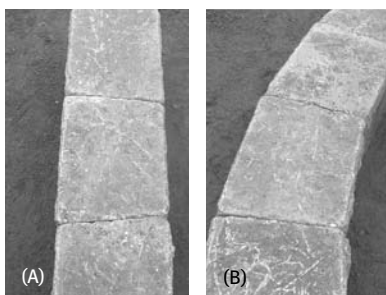

Double Sided Cast Stone Wall™

Tools: Shovel, wheelbarrow, level, string line, wooden stakes, dead blow hammer, and splitter for splitting block.

GENERAL INSTALLATION GUIDELINES:

Recommended maximum height: 4 courses (24") exposed not including cap. Install the first course of Double Sided Cast Stone Wall block with a gap of 1" separating the back of the blocks of the opposing walls.

EP Henry strongly recommends the use of high-strength concrete adhesive between every course and the cap. The 10" and 6" units will allow construction of radius walls with virtually no cuts.

CALCULATE MATERIAL NEEDED

Double Sided Cast Stone Wall™ is sold by the square foot. Calculate the total square feet of Double Sided Cast Stone Wall™ wall needed by multiplying the length times the exposed height.

Double Sided Cast Stone Wall™ has its own Footer Block which is sold by the piece. Calculate the number of units needed by dividing the length of the wall by 1.30 (decimal equivalent of 15 5/8").

PREPARE THE FOOTING

Dig a trench 24" wide and 10" below finished grade. Make sure the soil at the bottom of the trench is well compacted to prevent settling. In heavy or clay soils for best results, wrap the footer trench in a "U" shape configuration with geotextile. This will preserve the stone base over time and keep it from migrating into the clay soil. Using a vibratory plate compactor install 6" of dense graded aggregate (modified stone) or clean #57 stone in two 3" lifts making sure the surface of the last lift is smooth and level.

Tip: If using dense graded aggregate or modified stone: add a 1" layer of concrete sand or stone screenings on top of the footing as a leveling agent for the footer course.

INSTALLING THE FOOTER COURSE BLOCK

Install the Double Sided Cast Stone Wall™ Footer Block™ by placing the units tightly together on the prepared base. Level the units from front-to-back and side-to-side using a dead blow hammer and level. Radius construction will require the base course block to be spread apart (the gap should not exceed 4") and/or to be cut and trimmed accordingly using a diamond blade saw.

Note: These instructions are meant as a general guideline for walls under ideal conditions, and assuming no slopes or surcharges. Site-specific conditions may warrant additional installation requirements.

Caution: Dry sawing or grinding of concrete products may result in the release of respirable crystalline quartz. Prolonged exposure to respirable crystalline quartz may cause delayed (chronic) lung injury (silicosis). The use of a NIOSH-Approved respirator and tight-fitting goggles are recommended when sawing or grinding operations are in progress.

Double Sided Cast Stone Wall™

(continued)

INSTALLING DOUBLE SIDED CAST STONE WALL

Install the first course of Double Sided Cast Stone Wall™ block with the face of the unit overhanging the footer block while maintaining a gap of 1" separating the back of the blocks of the opposing walls. Check to make sure all units are level front-to-back, side-to-side and wall-to-wall. Install courses whenever possible so that each block spans the two units below it in a running bond pattern. Avoid having a vertical line extend more than two courses of block. Install additional courses starting at the corner and working toward the other end. Do not start at both corners and try to meet in the middle. Install the faces of the blocks flush to avoid gaps and to keep the continuity of the stone face on both sides of the wall. It is necessary to bond all the courses of block, the footer block, and the cap together. To achieve structural stability, beads of high strength, flexible concrete adhesive must be run between each course staying 1"-2" behind the face of the block.

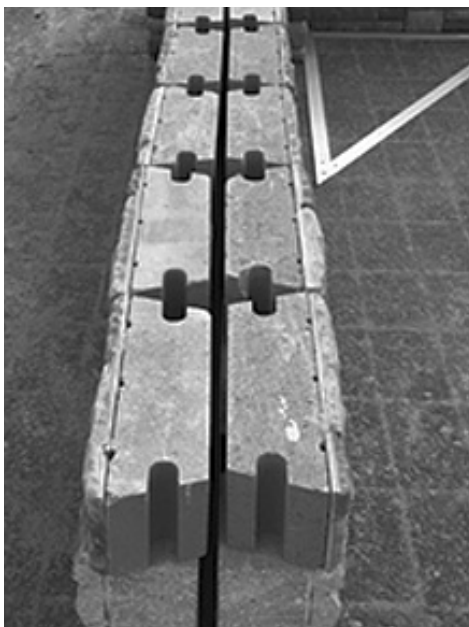

▲ Block Alignment

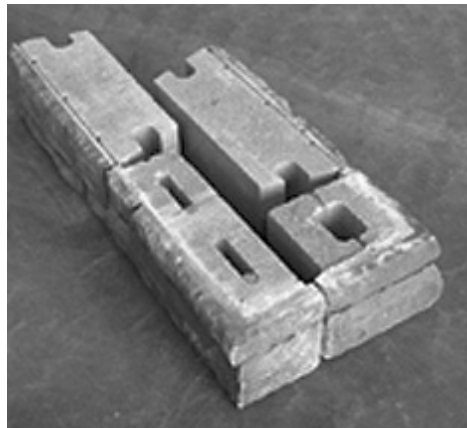

▲ Corner 1st Course



▲ Corner 2nd Course



▲ Corner 3rd Course

TERMINATING THE WALL

Double Sided Cast Stone Wall™ corners are manufactured in two unit sizes - 16"x 6" and 8"x 8" - to readily terminate the wall. At the termination point of the wall place the long and short corner units back-to-back as opposing pairs to create the end of the wall. (See below.) Alternate the position of the corner units on each successive course to maintain a running bond pattern. When terminating the wall make sure that the corner units overlap the two corner blocks beneath them maintaining a running bond.

Note: Double Sided Cast Stone Wall™ may also be terminated by building a column at the end of the wall using single sided Cast Stone Wall™ corner units with the column cap.

Cap options: Terra Vista Cap - minimum inside radius without cuts is 9' 10". Chapeau 16" Cap - minimum inside radius without cuts is 9' 6".

BUILDING 90° CORNERS

To build 90° corners install a Double Sided Cast Stone Wall™ "A" corner unit at the spot where one wall will terminate and the return wall begins. Work off of the "A" Corner unit using the 16" stretcher units. For each successive course of block alternate the position of the "A" Corner unit (see below). It is recommended to start construction at the corner and work out from that point. This insures virtually no cut pieces at the corner which means better structural stability and a cleaner overall appearance. Use a high-strength flexible concrete adhesive on all Double Sided Cast Stone Wall™ units when constructing the 90° corner.

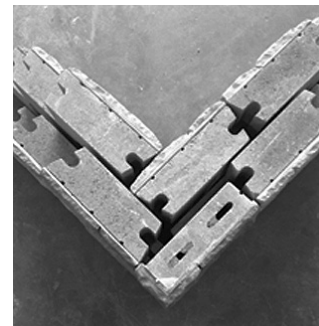
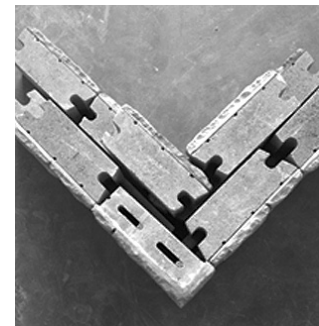
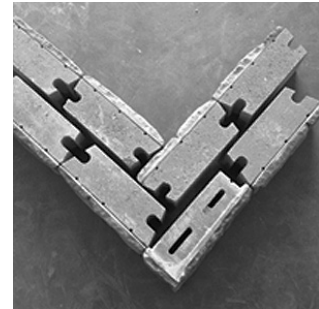

CAPPING THE WALL

After laying the last course of wall block, install the wall cap units using a high strength, flexible concrete adhesive applied to both sides of the wall. The cap units should be installed following the contour of the wall and with a uniform overhang on both sides. If needed, use a shim to eliminate any minor variations in height between the wall caps.

The EP Henry Double Sided Cast Stone Wall™ cap options can be installed by alternating the units front-to-back to cap a straight wall or by marrying the angles of the cap to conform to the wall's radius. Cutting the cap units may be necessary depending on the radius. All of the cap options have available finished end units for terminating the wall.

Rustic Double Face Wall

These installation instructions are for free-standing wall applications.

Tools:

- Shovel
- Wheelbarrow
- Level
- String line
- Hammer
- Tape measure
- Wooden stakes
- Dead blow hammer
- Chisel or splitter for splitting block
- Diamond blade cut off saw for cutting caps

GENERAL GUIDELINES

Rustic Double Face Wall comes in 1 shape: tapered units that may be used for constructing radius or straight walls.

Maximum height for Rustic Double Face Wall in freestanding applications without engineering assistance is 33" (exposed height including cap). Seek a qualified professional engineer where a taller wall may be required.

Curves in the wall, corners and piers that are joined into the wall will all help with the stability of your Rustic Double Face Wall.

Seat walls are typically 18"-24" high, parapet walls are typically 30"-33" high.

STEP 1: CALCULATE MATERIAL NEEDED

Rustic Double Face Wall is sold by the square foot. Determine the total square feet of wall needed by multiplying the length times the height (don't forget the block that will be below grade). Both the 3" high pallet and 6 high pallet contain 40 square feet of wall block. Due to Rustic Double Face Wall's modularity, both heights can be combined with the same wall.

Use the following formula to calculate the number of pins needed:

(Number of non-cap courses – 1) x lineal feet of wall = total number of pins.

Example: A wall 5 courses high (without cap), 20 feet long 5 (courses) – 1 (course) = 4 x 20 (feet) = 80 pins needed.

To calculate the number of universal caps needed: Total lineal feet divided by 1.25 = total number of Universal Caps needed

Example: 20-foot long wall 20 (feet) divided by 1.25 = 16 Universal Caps needed

STEP 2: PREPARE THE FOOTING

Dig a trench at least 20" wide (make sure it's wide enough to accommodate your plate compactor). The trench should be a minimum of 12" deep, enough to bury the first course of block (6") plus (6") for the depth of footer material (3/4" modified stone).

Make sure the soil in the bottom of the trench is well compacted to prevent settling. Add a level, even 6" thick layer of 3/4" modified stone as a footing. Do this in two 3" layers, compacting each with a vibratory plate compactor. Make sure the surface of the second layer is smooth and level. Screenings or coarse concrete sand may be used as a leveling agent, but should not exceed 1" in depth. This should be applied using a 1" high screed rail and leveling the screenings or coarse concrete sand uniformly on the surface.

STEP 3: INSTALL THE BASE COURSE

Install the first layer of Rustic Double Face Wall by placing the units, narrowest slot (1/2" wide) on the top, on the prepared base. Depending on the radius you are trying to achieve you may need to turn a block upside down for ease of installation. It is recommended that 6 units be used for the first course to help ensure the wall's stability.

Level the units from front to back and side-to-side using a dead blow hammer and level.

Rustic Double Face Wall blocks come in three different sizes. Use 6" x 16" for setting the first course. Align the base course to a string line to assure a straight wall where applicable.

Note: EP Henry now offers Base Course Block, which facilitates ease of installation and provides improved structural stability.

STEP 4: INSTALLING ADDITIONAL COURSES

Place the next and additional courses of Rustic Double Face Wall in such a fashion that each block bridges two units below in a running bond pattern, wherever possible. Avoid having a vertical line span more than two layers, or 6" of block. Lay additional courses starting at the corner and working toward the center.

Insert pins in each course as you build the wall, making sure that the flag of every pin is oriented toward the wider part of the block. Marry the angles of the blocks to avoid gaps and to keep the continuity of the rockface on both sides of the wall. The tightest radius possible using all unit sizes is 48 inches. By using more of the smaller blocks and less of the larger units you can achieve a tighter radius.

Run a bead of high strength, flexible concrete adhesive on either side of the slot about 1"-2" from both of the faces of the block.

STEP 5: BUILDING 90° CORNERS

Double sided corners are available in both 3" and 6" high units to readily create 90° corners. To build 90° corners, begin construction at the corner of the wall and work out. Alternate corner units in the opposing direction to maintain a running bond pattern.

Start by laying the corner unit first and work your base course away from the corner unit. After installing and leveling your base course, start the second course again at the corner. No pins will be used in the corner; use high strength, flexible concrete adhesive only. When building a corner, make sure that the corner unit overlaps two blocks beneath.

After splitting the corner, take a piece of block and rake the face of the fresh split to create a distress look.

STEP 6: CAP THE WALL

After installing your last course of wall block, attach the Universal Wall Caps with a high-strength, flexible concrete adhesive. The cap units should be installed following the contour of the wall and with a 3/4"-1" overhang on both sides. Universal Wall Caps will fit a 6' 6" inside radius with no cuts.

Alternate Universal Caps for a straight wall.

For a curved wall, marry the angles of the cap to conform to the radius. Some cutting may be necessary.

Note: For correct alignment and pin placement, Rustic Double Face Wall must be built in the free-standing Wall configuration with no gaps between the blocks.

ADDITIONAL TIPS: BUILDING 90° CORNERS

Special units are available to construct true 90° corners. They are 14" long and available in both 3" and 6" heights, and right and left versions. To build 90° corners, begin construction at the corner of the wall and work out. Alternate the long dimension of corner units to maintain a running bond pattern. Use a high strength flexible adhesive to bond the corner block together as there are no slots for pins. Also, any single battered wall with a 90° corner on each end requires cutting the corner units to accommodate the wall batter as the wall rises to maintain the running bond pattern.

STEPS

The installation of steps requires careful layout and planning. It is critical that the base be properly installed; see Step 2 for details. A minimum of 6" of modified stone base is required under all risers. Check local construction codes for minimum riser height and tread depth. Use the wall blocks to create the riser and the Universal Caps for the tread. Bullnose Pavers may also be used for the tread. When constructing steps, bury a block behind the visible riser. In other words, each step should be at least two blocks deep. This will give the tread (cap) more stability by allowing the front block of the upper step to bear on the back block of the lower step. Use a high strength concrete adhesive to attach the treads to the risers.

See page 19 for Typical Wall Installation diagram and page 20 for Inset and Exposed Steps diagrams.

Caution: Dry sawing or grinding of concrete products may result in the release of respirable crystalline quartz.

Prolonged exposure to respirable crystalline quartz may cause delayed (chronic) lung injury (silicosis). The use of a NIOSH-Approved respirator, tight fitting goggles and hearing protection is recommended when sawing or grinding operations are in progress.



Cast Stone Wall™

Tools/equipment: Excavating equipment, shovel, wheelbarrow, level, string line, wooden stakes, dead blow hammer, vibratory plate compactor.

CALCULATE MATERIALS NEEDED

Refer to the Terrace Wall Calculator.

PREPARE THE FOOTING

Dig a trench 24" wide and a minimum of 12" below grade. Make sure the soil at the bottom of the trench is well compacted to prevent settling. In heavy or clay soils for best results, wrap the footer trench in a "U" shape configuration with geotextile. This will preserve the stone base over time and keep it from migrating into the clay soil. Using a vibratory plate compactor install 6" of modified stone in two 3" layers making sure the surface of the last layer is smooth and level.

Tip: Add a uniform 1" layer of sand or stone screenings on top of the footing to make the base course easier to level.

INSTALL THE BASE COURSE USING TERRACE WALL™

Install the Terrace Wall as the base course by placing the units, lip side down, on the prepared base (to make leveling the base course easier

remove the lip by chipping it off with a hammer). Level the Terrace Wall base course units from front to back and side-to-side using a dead blow hammer and level. Use a string line along the back of the block to verify straightness.

Note: Core fill all units with #57 (1-1/4", 3/4" and 1/2") or #67 (3/4") clean stone. Crushed or recycled concrete is NOT suitable for this purpose.

BACKFILL THE UNITS

Backfill at least 12" behind each layer of Cast Stone Wall with #57 (1-1/4", 3/4" and 1/2") or #67 (3/4") clean stone (for drainage) with soil behind the drainage stone. All disturbed areas behind the units must be filled and compacted.

Tip: One ton of 3/4" clean stone will core fill and back fill about 21 Cast Stone Wall blocks.

INSTALLING ADDITIONAL COURSES

Place the next and additional courses of Cast Stone Wall in such a fashion that each block bridges two units below in a running bond pattern. Cast Stone Wall is intended to be built as a vertical wall system. Use a level against the back of the blocks to determine vertical alignment from course to course. Use a high strength, flexible concrete adhesive to bond every course to the one below including the Terrace Wall base course. Backfill each course as the wall is being built and

fill the block cores with #57 (1-1/4", 3/4" and 1/2") or #67 (3/4") clean stone.

CAP THE WALL

Cut caps with a diamond blade saw to fit, as needed. Attach the wall cap block with a high strength, flexible concrete adhesive.

Note: the minimum inside radius for Chapeau 14" cap is 15'.

ADDITIONAL TIPS:

BUILDING 90° CORNERS

Full Face and Random Face 8"x6"x16" units with a finished end are available for 90° corners.

CONSTRUCTING CURVED OR SERPENTINE WALLS

The tapered shape of Cast Stone Wall makes it easy to create curved walls without any additional work.

CONSTRUCTING STEPS

Attractive steps, in either straight or semi-circular designs, are easy to build with Cast Stone Wall units. The block units are used for the risers, with the block caps or another material, such as Bullnose Pavers, used for the tread. Use the Step Filler block in step applications where the product will not be visible.

Terrace Wall™

Tools: Shovel, wheelbarrow, level, string line, wooden stakes, dead blow hammer, and splitter for splitting block.

CALCULATE MATERIALS NEEDED

Refer to the Terrace Wall Calculator.

PREPARE THE FOOTING

Dig a trench 24" wide and a minimum of 12" below grade depending on the overall height of the wall. As a rule of thumb, you will bury 10 percent of the wall height or a minimum of 6", whichever is greater. Make sure the soil at the bottom of the trench is well compacted to prevent settling. In heavy or clay soils for best results, wrap the footer trench in a "U" shape configuration with geotextile. This will preserve the stone base over time and keep it from migrating into the clay soil. Using a vibratory plate compactor install 6" of modified stone in two 3" layers making sure the surface of last layer is smooth and level.

Tip: Add a 1" layer of sand or stone screenings on top of the footing to make the base course easier to level.

INSTALL THE BASE COURSE

Install the first layer of Terrace Wall by placing the units, lip side down, on the prepared base

(remove the lip with a hammer to make leveling easier). Level the units from front to back and side-to-side using a dead blow hammer and level. Use a string line along the back of the block to verify straightness.

BACKFILL THE UNITS

Backfill at least 12" behind each layer of Terrace Wall with #57 (1-1/4", 3/4" and 1/2") or #67 (3/4") clean stone (for drainage) with soil behind it. All areas behind the units must be filled and compacted.

Tip: One ton of 3/4" clean stone will core fill and back fill about 21 Terrace Wall blocks.

INSTALLING ADDITIONAL COURSES

Place the next and additional courses of Terrace Wall in such a fashion that each block bridges two units below in a running bond pattern. Pull the units forward so that the lip rests against the back edge of the course underneath (your wall will step back 7/8" for every layer). Backfill each course as the wall is being built and fill the block cores with #57 (1-1/4", 3/4" and 1/2") or #67 (3/4") clean stone.

Note: Core fill all units with #57 (1-1/4", 3/4" and 1/2") or #67 (3/4") clean stone. Crushed or recycled concrete is NOT suitable for this purpose.

ADDITIONAL TIPS:

BUILDING 90° CORNERS

8"x6"x16" units with a finished end are available for 90° corners.

CONSTRUCTING CURVED OR SERPENTINE WALLS

The tapered shape of Terrace Wall makes it easy to create curved walls without any additional work.

CONSTRUCTING STEPS

Attractive steps, in either straight or semi-circular designs, are easy to build with Terrace Wall units. The block units themselves are used for the risers, with the cap block or another material, such as Bullnose Pavers, used for the tread.

Terrace Wall Calculator

		WALL LENGTH														
		1'4"	2'8"	4'0"	5'4"	6'8"	8'0"	9'4"	10'8"	12'0"	13'4"	14'8"	16'0"	17'4"	18'8"	20'0"
WALL HEIGHT	6"	1	2	3	4	5	6	7	8	9	10	11	12	13	14	15
	1'0"	2	4	6	8	10	12	14	16	18	20	22	24	26	28	30
	1'6"	3	6	9	12	15	18	21	24	27	30	33	36	39	42	45
	2'0"	4	8	12	16	20	24	28	32	36	40	44	48	52	56	60
	2'6"	5	10	15	20	25	30	35	40	45	50	55	60	65	70	75
	3'0"	6	12	18	24	30	36	42	48	54	60	66	72	78	84	90
CAPS		1	2	3	4	5	6	7	8	9	10	11	12	13	14	15

Maximum unreinforced wall height is 36" (6 courses).
Standard Unit Size: 12"Dx6"Hx16"W
Weight: Approx. 51 lbs. Corner: 8"Dx6"Hx16"W
Weight: Approx. 45 lbs.

Cap Unit Size: 12"Dx3"Hx16"W Weight: Approx. 47 lbs.
Universal Cap: 11^{3/8}"Dx3"Hx14" or 16"W
Weight: Approx. 44 lbs.



StoneWall® Select®, Mesa®, Diamond Pro® and Vertica®

Before you begin, call your local utilities companies to check your yard for buried electrical lines, cables, etc. This step is essential for your safety and is required by law. This service is free in most areas. Also, check with your local municipality to see if you'll need a construction permit and/or a fence behind your segmental retaining wall.

Tools: Shovel, wheelbarrow, level, string line, tape measure, wooden stakes, dead blow hammer or splitter for splitting block.

CALCULATE MATERIALS NEEDED

One block equals one square foot of wall face area. Each 4" thick cap is 18" in length, so divide the linear length of the wall by 1.5 to determine the number of cap units.

Mesa and StoneWall Select each require two clips/connectors per unit, except for the course below the cap. Diamond Pro and Vertica do not require clips or connectors.

LAY OUT THE PROJECT AND PREPARE THE FOOTING (LEVELING PAD)

Begin your project by staking out the layout of the wall you are going to build. Excavate a 24" wide trench centered along this line. Make the trench a minimum of 14" deep, enough to bury the first course of block (8") plus 6" for the footer. Ensure that a minimum of 8" or 10 percent of the total wall height (which ever is greater) will be below grade. Compact the soil in the bottom of the trench with a mechanical plate compactor before installing the footer material. The footing material should be 3/4" minus with fines (2A modified stone), compacted to 95 percent standard proctor density before proceeding to install the base course. Remember: Construct the wall level, NOT following the grade.

INSTALL THE BASE COURSE

Spreading a uniform 1" layer of concrete sand over your base will make it easier to level your first course of block. Ensure that the base course is level. Level the unit side-to-side and from front-to-back using a dead blow hammer and level. Use a string line along the back of the block to verify straightness.

Mesa Lay the unit so that the slots are face up.

StoneWall Select Lay the unit so that the clip groove is face up.

Diamond Pro Remove the rear lip of each base course unit and level.

Vertica Lay the unit so that the center locator lug is face up.

NEXT COURSE CONSTRUCTION

Mesa Place two connectors into the receiving slots on the top of each Mesa unit. The teeth of the Mesa connector must penetrate the Tensar® geogrid apertures on courses that require geogrid. The transverse bar should be snug against the connector teeth before final seating of the connector. Seat the connector by lightly tapping it with a hammer. Flags on top of the Mesa connector must be oriented in the proper direction for a "battered" or "near vertical" wall, as per the project requirements. Placement of the connector with flags forward pointing toward the face of the wall will render a near vertical wall batter, while flags pointed away from the wall face will provide a 5/8" setback.

StoneWall Select Place two interlocking clips onto the back of each unit. The sides of the clips indicate the up and front direction to create the 3/4" setback.

Diamond Pro No connectors/clips are needed. Pull each block forward as far as possible to engage the rear lip and ensure the correct 1" setback.

Vertica No connectors/clips are needed. Pull each block forward as far as possible to ensure the correct 1/2" setback. Clean any debris off the top of the units. Place the next and additional courses in such a fashion that each unit bridges two units below in a running bond pattern.

BACKFILL AND COMPACT

After each course of block is laid, backfill your wall. First, shovel drainage stone #57 (1-1/4", 3/4" and 1/2") or #67 (3/4") clean stone directly behind the new course of blocks, extending back a minimum of 12". Fill the cores and surrounding voids with #57 (1-1/4", 3/4" and 1/2") or #67 (3/4") clean stone. Crushed or recycled concrete is NOT suitable for this purpose. Include a 4" perforated pipe (drain tile) with a minimum one percent pitch behind the units and route the pipe through the face of the wall at grade level, or alongside if possible. Compact the area behind the wall to 95 percent proctor density. Using suitable compaction equipment appropriate for your soil type and lift thickness. Compact no more than 4' of soil at a time. Always run equipment parallel to wall.

GEOGRID REINFORCEMENT

Where applicable, install geogrid to the specified length (block surface should be clean and free of debris, and backfill should be level with the top of the wall block). Make sure that the strength direction of the grid is perpendicular to the wall. Install the interlocking clips or connectors after the geogrid is in position. Place additional geogrid lengths as required by the engineer's plans. Place the front edge of the geogrid 1" from the face of the block. Always pull the reinforcement taut and pin or stake the grid so it lies completely flat with its back edge in place. Remember: Use only Tensar geogrid with the Mesa Wall System.

CAP THE WALL

Cut caps with a diamond blade saw to fit, as needed. Attach the wall cap block with a high strength, flexible concrete adhesive.



▲ Mesa



▲ Vertica Stone Cut



▲ StoneWall SELECT

Note: These instructions are meant as general guidelines for walls less than 40" (five courses). Walls higher than 40" generally require geogrid reinforcement to stabilize the soil behind the wall. Site-specific conditions may warrant additional installation requirements. EP Henry recommends you consult a Professional Engineer for all walls over 48" or walls lower than 48" with a significant surcharge.

Caution: Dry sawing or grinding of concrete products may result in the release of respirable crystalline quartz. Prolonged exposure to respirable crystalline quartz may cause delayed (chronic) lung injury (silicosis). The use of a NIOSH-Approved respirator and tight-fitting goggles are recommended when sawing or grinding operations are in progress.

TYPICAL WALL

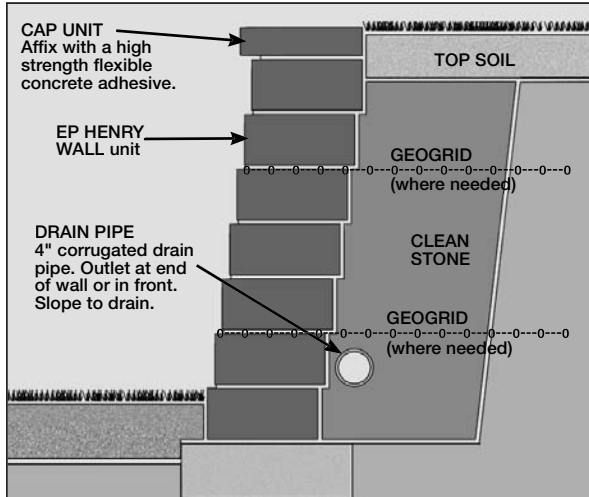

RAISED PATIO CONSTRUCTION

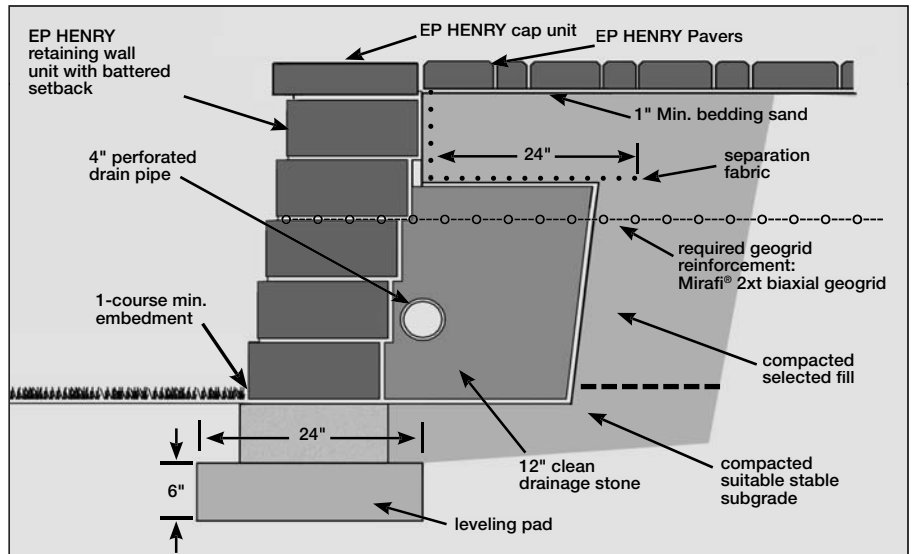

90° CORNERS

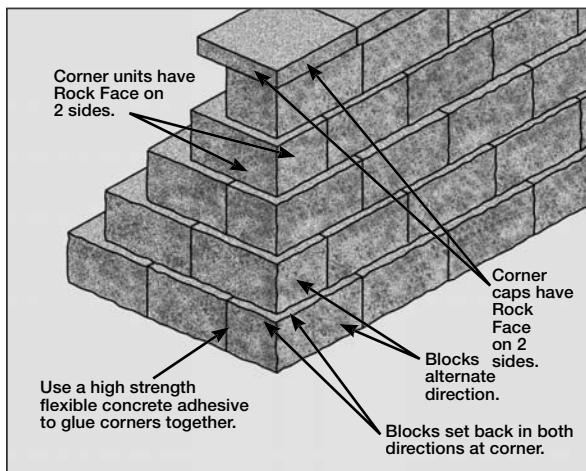

INSET STEP

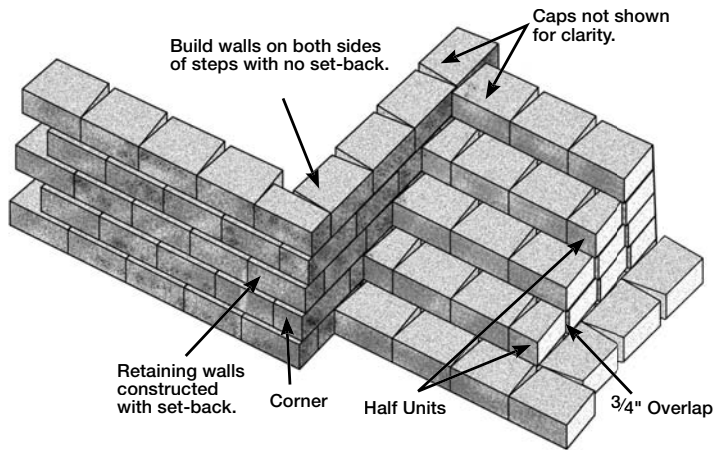

LAMPOST CONSTRUCTION

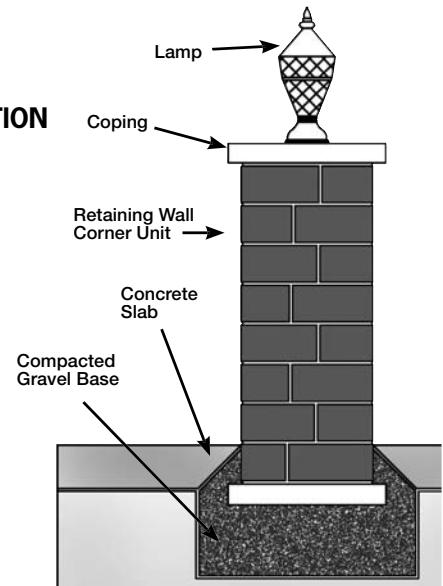

EXPOSED STEP

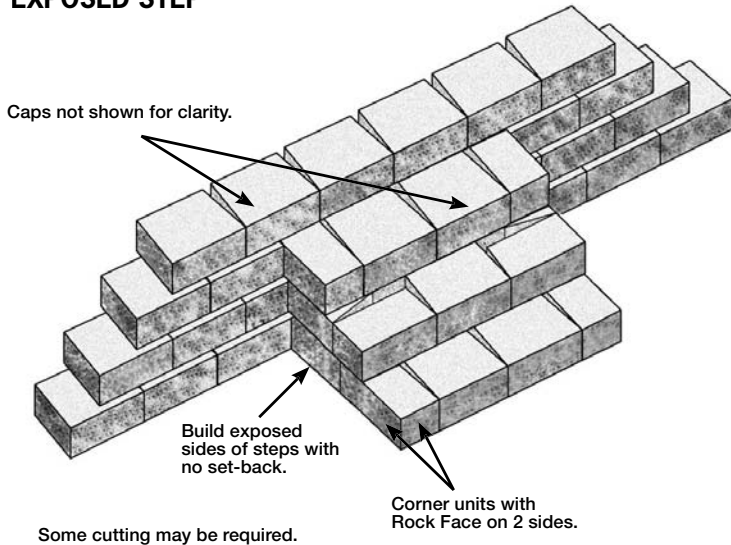



TYPICAL CURVES

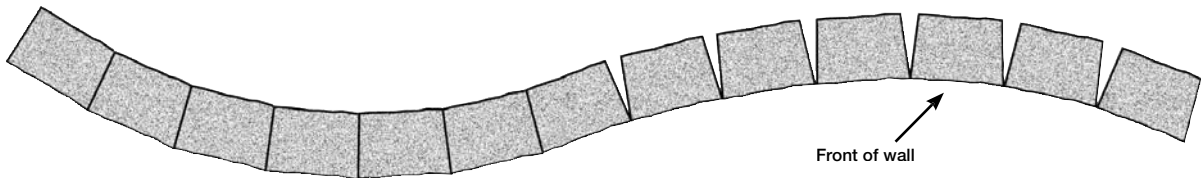

WALL WITH UNIVERSAL CAPS

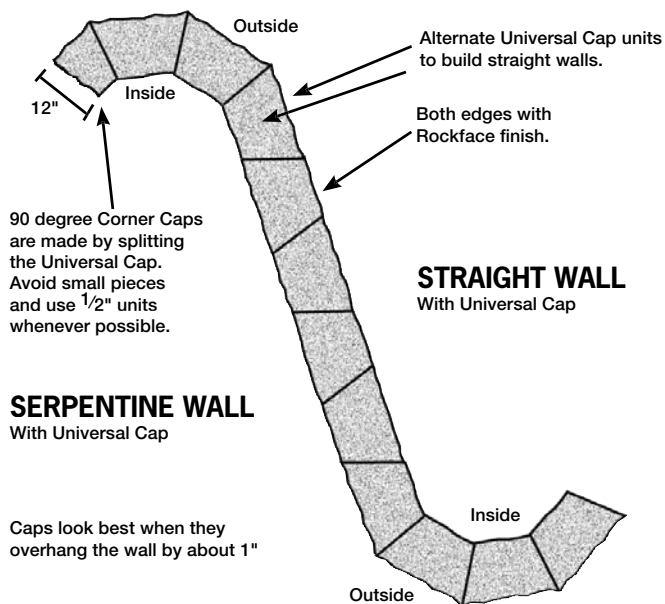

STRAIGHT WALL With Universal Cap

WALL TRANSITIONS

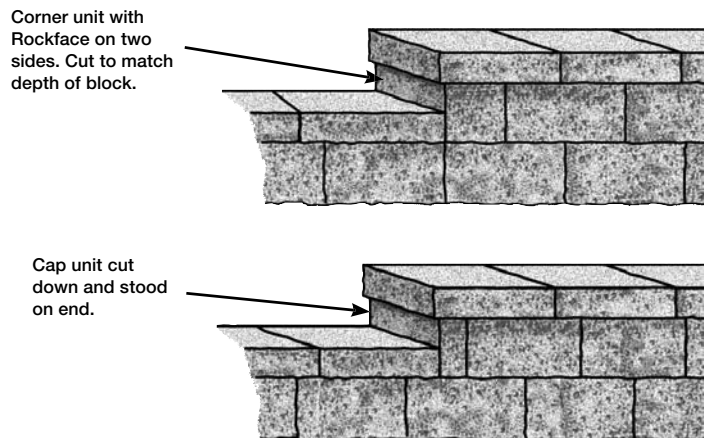

SERPENTINE WALL With Universal Cap

Caps look best when they overhang the wall by about 1"

CUTTING CAPS

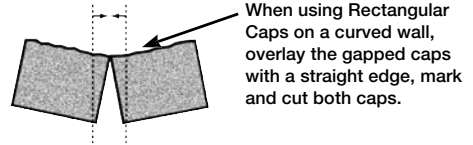

Geogrid Reinforcement for Retaining Walls

A gravity wall is one in which the size and mass of the block alone is sufficient to hold back the soil. Geogrid may be required to reinforce your retaining wall if any of the following conditions exist:

- The wall exceeds a certain height, normally 3' to 4' (depending upon the system used)
- Excessive surcharges or loading (e.g., parking lots, driveways, structures) will be applied to the wall
- Poor quality soils are on-site
- The ground is sloped at either the top or bottom of the wall
- The wall will be used in water applications

WHAT IS GEOGRID?

Geogrid is flexible synthetic mesh with high tensile strength, typically comprised of High Density Polyethylene (HDPE) or woven polyester with a coating. These products are flexible, very durable, and have long-term design strength that creates a reinforced soil mass.

Base Course Block

EP Henry offers two options for Base Course Block depending on the wall system and design you are executing.

Save time and money with EP Henry's Base Course Block. Designed to work with many of our most popular wall systems, it provides enhanced structural stability while its tapered design allows for soft curves with fewer cuts.

Cubing Information

BASE COURSE BLOCK	
LBS EACH	86
PIECES PER CUBE	45
LBS PER CUBE	3,870

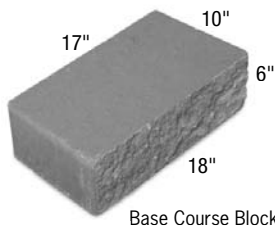

For applications requiring geogrid, EP Henry recommends the Mirafi® "XT" line, except for the Mesa® Retaining Wall System, which has its own specialized geogrid, Tensar®.

HOW DOES IT WORK?

Geogrid is designed to create a reinforced coherent mass behind the wall. In other words, it acts to connect the block, drainage stone, and retained soil.

HOW IS IT INSTALLED?

Geogrid is installed between the layers of block, perpendicular to the wall face and back into the retained soil (see photo below). Proper installation and compaction of the soil in the reinforced zone is critical.

Most geogrids are directional fabrics and must be oriented a certain way to perform properly. Follow the manufacturer's directions accordingly.

Geogrid installation procedures may vary for each wall system. Specific information is available for each.

HOW MUCH GEOGRID IS NECESSARY?

Many factors come into play when determining how many layers of geogrid are necessary, their positioning, and length. Soil type, wall height and location, and any surcharges all contribute to these calculations. A licensed, geotechnical engineer will be able to provide this as part of a design package. Charts are also available for most wall systems, which give conservative quantity estimates.

For more detailed information on geogrid design, engineering, and installation, please contact your local EP Henry Authorized Hardscaping Distributor®.



▲ Geogrid Installation

Anchor® Torpedo™ Base Block

Save time and money with improved jobsite efficiency by using the new Torpedo™ base block. This strong, lightweight block is a great foundation for retaining walls built up to gravity wall height with rear-lipped Anchor™ retaining wall products and for Anchor freestanding wall systems.

Integral hand-holds make this new product easy to place and to lift when repositioning, and the hollows under the block absorb base aggregates for better leveling. And, no core-fill is needed. The Torpedo base blocks are shaped to fit together to hold their position as they are placed. Ready to use, there are no lips to remove or pins to place. The blocks level and install quickly, are very maneuverable and can be used for curves, corners, columns and straight walls.

Cubing Information

TORPEDO BASE BLOCK	
LBS EACH	48
PIECES PER CUBE	48
LBS PER CUBE	2,385

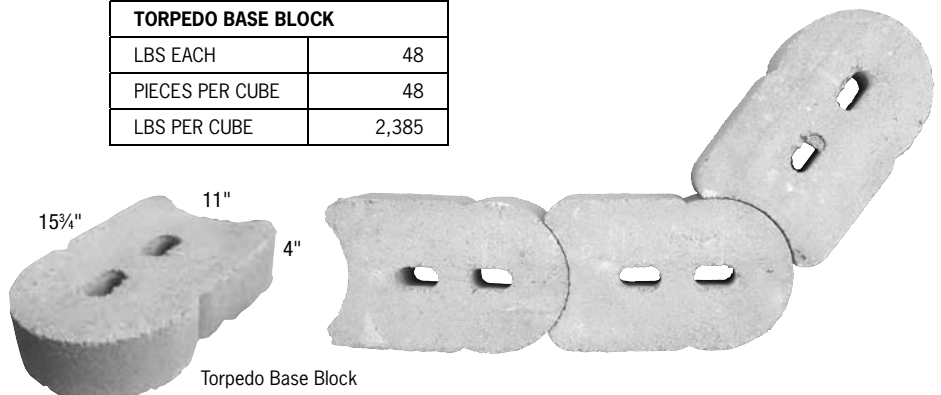

FOR GRID ESTIMATING PURPOSES ONLY

**Case 1 with $\phi = 27$ degrees
NO SURCHARGE
NO SLOPE AT TOP OF WALL**

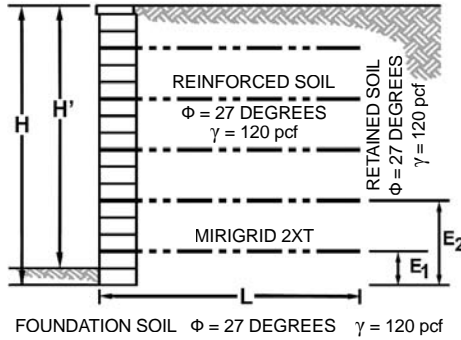

Exposed Height H', (ft)	Total Height H, (ft)	No. of Cast Stone Courses	Grid Layers	Length L, (ft)	Layer Number - Place Grid Elevation E _i , (ft)							
					1	2	3	4	5	6	7	
1.8	2.3	4	1	4.0	1.0							
2.3	2.8	5	1	4.0	1.0							
2.8	3.3	6	2	4.0	1.0	2.0						
3.3	3.8	7	2	4.0	1.0	2.5						
3.8	4.3	8	2	4.0	1.0	2.5						
4.3	4.8	9	3	5.0	1.0	2.5	3.5					
4.8	5.3	10	3	5.0	1.0	2.5	3.5					
5.3	5.8	11	3	5.0	1.0	2.5	4.0					
5.8	6.3	12	4	6.0	1.0	2.5	4.0	5.0				
6.3	6.8	13	4	6.0	1.0	2.5	4.0	5.0				
6.8	7.3	14	4	7.0	1.0	2.5	4.0	5.5				
7.3	7.8	15	5	7.0	1.0	2.5	4.0	5.5	6.5			
7.8	8.3	16	5	7.0	1.0	2.5	4.0	5.5	6.5			
8.3	8.8	17	5	7.5	1.0	2.5	4.0	5.5	7.0			

**Case 2 with $\phi = 27$ degrees
SURCHARGE FROM ROADWAY OR PARKING
NO SLOPE AT TOP OF WALL**

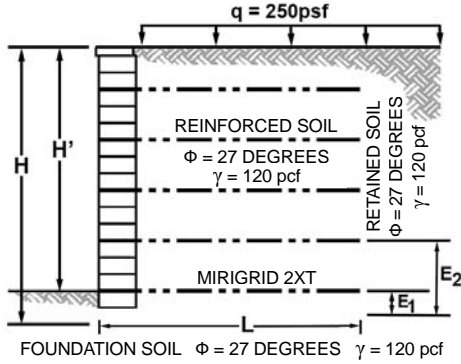

1.8	2.3	4	1	5.0	0.5							
2.3	2.8	5	2	5.0	0.5	1.5						
2.8	3.3	6	2	5.5	1.0	2.0						
3.3	3.8	7	2	5.5	1.0	2.0						
3.8	4.3	8	2	6.5	1.0	2.5						
4.3	4.8	9	3	6.5	1.0	2.5	3.5					
4.8	5.3	10	3	7.5	1.0	2.5	4.0					
5.3	5.8	11	3	7.5	1.0	2.5	4.0					
5.8	6.3	12	4	7.5	1.0	2.5	4.0	5.0				
6.3	6.8	13	4	8.5	1.0	2.5	4.0	5.5				
6.8	7.3	14	4	8.5	1.0	2.5	4.0	5.5				
7.3	7.8	15	5	9.0	1.0	2.5	4.0	5.5	6.5			
7.8	8.3	16	5	9.0	1.0	2.5	4.0	5.5	6.5			
8.3	8.8	17	5	9.5	1.0	2.5	4.0	5.5	7.0			

**Case 3 with $\phi = 27$ degrees
NO SURCHARGE
3:1 MAX SLOPE AT TOP OF WALL**

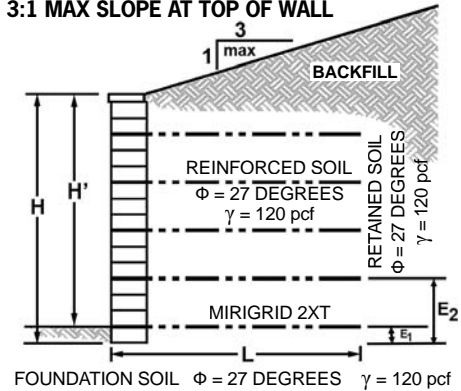

1.8	2.3	4	1	4.0	1.0							
2.3	2.8	5	1	4.0	1.0							
2.8	3.3	6	2	4.0	1.0	2.0						
3.3	3.8	7	2	4.5	1.0	2.5						
3.8	4.3	8	2	4.5	1.0	2.5						
4.3	4.8	9	3	6.0	1.0	2.5	3.5					
4.8	5.8	11*	3	6.0	1.0	2.5	4.0					
5.3	6.3	12*	3	7.0	1.0	2.5	4.0	5.0				
5.8	6.8	13*	4	7.0	1.0	2.5	4.0	5.0				
6.3	7.3	14*	4	8.5	1.0	2.5	4.0	5.5				
6.8	7.8	15*	4	8.5	1.0	2.5	4.0	5.5	6.5			
7.3	8.3	16*	5	8.5	1.0	2.5	4.0	5.5	6.5			
7.8	8.8	17*	5	9.0	1.0	2.5	4.0	5.5	7.0			

*REQUIRES TWO FULL COURSES BURIED

Notes:

- Information presented in this chart is to be used for preliminary design and estimating purposes. Final design should be performed by a Professional Engineer qualified in both geotechnical engineering and segmental retaining wall design.
- This estimating chart is applicable to sites where soil conditions meet the following minimum criteria: Angle of Internal Friction, $\phi > 27^\circ$ and moist unit weight, $\gamma = 120\text{pcf}$. Typical for low plasticity silts meeting the following USCS classification: ML or coarser.
- Design charts prepared for use with EP Henry's Cast Stone Wall block system with Mirafi's type 2XT reinforcing geogrids. Grids MUST extend to the front face of the block.

4. Definitions:

- H' = exposed height, in feet
 - H = total height, in feet
 - L = length of Mirafi 2XT required, in feet
 - ϕ = angle of internal friction, degrees
 - γ = moist unit weight, pounds per cubic foot
 - E = elevation of grid layer from bottom of wall, in feet
5. These charts do not reflect any provisions for global stability or other analyses, which may be related to site-specific conditions including relief of excess hydrostatic pressures due to groundwater or springs. All these conditions should be checked and evaluated as appropriate, using site specific soil and subsurface conditions, as well as any special loading criteria.
6. Design Minimum Factors of Safety: 1.5 for reinforcement

pullout, 1.5 for external sliding, 2.0 for overturning, and 2.0 for bearing.

- All walls shall be supported on an aggregate leveling pad and shall have adequate drainage provisions in accordance with EP Henry's standard specification guidelines.
- To the best of our knowledge, the information presented in this design chart is complete and accurate. However, EP Henry Corporation cannot assume any liability or accept any responsibility for the accuracy or completeness of this information. Further, EP Henry Corporation cannot assume any liability for damages arising from claims in which construction proceeded without final design drawings prepared by a Professional Engineer registered in the State of construction specializing in both geotechnical engineering and segmental retaining wall design.

Cast Stone Wall Grid Charts

www.ephenry.com/technical

FOR GRID ESTIMATING PURPOSES ONLY

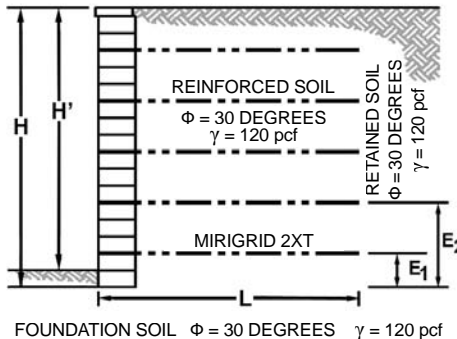
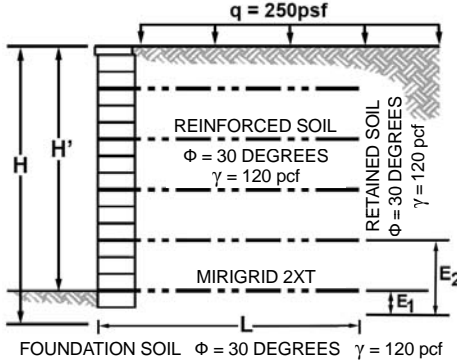
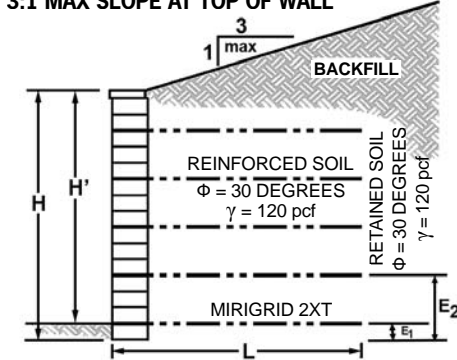
	Exposed Height H', (ft)	Total Height H, (ft)	No. of Cast Stone Courses	Grid Layers	Length L, (ft)	Layer Number - Place Grid Elevation E _r (ft)									
						1	2	3	4	5	6	7			
Case 1 with $\phi = 30$ degrees NO SURCHARGE NO SLOPE AT TOP OF WALL 	2.3	2.8	5	1	4.0	1.0									
	2.8	3.3	6	2	4.0	1.0	2.0								
	3.3	3.8	7	2	4.0	1.0	2.5								
	3.8	4.3	8	2	4.0	1.0	2.5								
	4.3	4.8	9	3	4.5	1.0	2.5	3.5							
	4.8	5.3	10	3	4.5	1.0	2.5	3.5							
	5.3	5.8	11	3	5.5	1.0	2.5	4.0							
	5.8	6.3	12	4	5.5	1.0	2.5	4.0	5.0						
	6.3	6.8	13	4	5.5	1.0	2.5	4.0	5.0						
	6.8	7.3	14	4	6.5	1.0	2.5	4.0	5.5						
7.3	7.8	15	5	6.5	1.0	2.5	4.0	5.5	6.5						
7.8	8.3	16	5	6.5	1.0	2.5	4.0	5.5	6.5						
8.3	8.8	17	5	7.0	1.0	2.5	4.0	5.5	7.0						
Case 2 with $\phi = 30$ degrees SURCHARGE FROM ROADWAY OR PARKING NO SLOPE AT TOP OF WALL 	1.8	2.3	4	1	4.0	0.5									
	2.3	2.8	5	2	4.0	0.5	1.5								
	2.8	3.3	6	2	4.5	1.0	2.0								
	3.3	3.8	7	2	4.5	1.0	2.0								
	3.8	4.3	8	2	5.5	1.0	2.5								
	4.3	4.8	9	3	5.5	1.0	2.5	3.5							
	4.8	5.3	10	3	5.5	1.0	2.5	3.5							
	5.3	5.8	11	3	6.5	1.0	2.5	4.0							
	5.8	6.3	12	4	6.5	1.0	2.5	4.0	5.0						
	6.3	6.8	13	4	6.5	1.0	2.5	4.0	5.0						
6.8	7.3	14	4	7.5	1.0	2.5	4.0	5.5							
7.3	7.8	15	5	7.5	1.0	2.5	4.0	5.5	6.5						
7.8	8.3	16	5	7.5	1.0	2.5	4.0	5.5	6.5						
8.3	8.8	17	5	8.0	1.0	2.5	4.0	5.5	7.0						
Case 3 with $\phi = 30$ degrees NO SURCHARGE 3:1 MAX SLOPE AT TOP OF WALL 	1.8	2.3	4	1	4.0	1.0									
	2.3	2.8	5	1	4.0	1.0									
	2.8	3.3	6	2	4.0	1.0	2.0								
	3.3	3.8	7	2	4.5	1.0	2.5								
	3.8	4.3	8	2	4.5	1.0	2.5								
	4.3	4.8	9	3	6.0	1.0	2.5	3.5							
	4.8	5.3	11*	3	6.0	1.0	2.5	4.0							
	5.3	5.8	12*	3	7.0	1.0	2.5	4.0	5.0						
	5.8	6.3	13*	4	7.0	1.0	2.5	4.0	5.0						
	6.3	6.8	14*	4	7.0	1.0	2.5	4.0	5.5						
6.8	7.3	15*	4	8.0	1.0	2.5	4.0	5.5	6.5						
7.3	7.8	16*	5	8.0	1.0	2.5	4.0	5.5	6.5						
7.8	8.3	17*	5	8.0	1.0	2.5	4.0	5.5	7.0						

*REQUIRES TWO FULL COURSES BURIED

Notes:

- Information presented in this chart is to be used for preliminary design and estimating purposes. Final design should be performed by a Professional Engineer qualified in both geotechnical engineering and segmental retaining wall design.
- This estimating chart is applicable to sites where soil conditions meet the following minimum criteria: Angle of Internal Friction, $\phi > 30^\circ$ and moist unit weight, $\gamma = 120\text{pcf}$. Typical for low plasticity silts meeting the following USCS classification: ML or coarser.
- Design charts prepared for use with EP Henry's Cast Stone Wall block system with Mirafi's type 2XT reinforcing geogrids. Grids MUST extend to the front face of the block.

4. Definitions:

- H' = exposed height, in feet
 H = total height, in feet
 L = length of Mirafi 2XT required, in feet
 ϕ = angle of internal friction, degrees
 γ = moist unit weight, pounds per cubic foot
- These charts do not reflect any provisions for global stability or other analyses, which may be related to site-specific conditions including relief of excess hydrostatic pressures due to groundwater or springs. All these conditions should be checked and evaluated as appropriate, using site specific soil and subsurface conditions, as well as any special loading criteria.
 - Design Minimum Factors of Safety: 1.5 for reinforcement

pullout, 1.5 for external sliding, 2.0 for overturning, and 2.0 for bearing.

- All walls shall be supported on an aggregate leveling pad and shall have adequate drainage provisions in accordance with EP Henry's standard specification guidelines.
- To the best of our knowledge, the information presented in this design chart is complete and accurate. However, EP Henry Corporation cannot assume any liability or accept any responsibility for the accuracy or completeness of this information. Further, EP Henry Corporation cannot assume any liability for damages arising from claims in which construction proceeded without final design drawings prepared by a Professional Engineer registered in the State of construction specializing in both geotechnical engineering and segmental retaining wall design.

FOR GRID ESTIMATING PURPOSES ONLY

**Case 1 with $\phi = 32$ degrees
NO SURCHARGE
NO SLOPE AT TOP OF WALL**

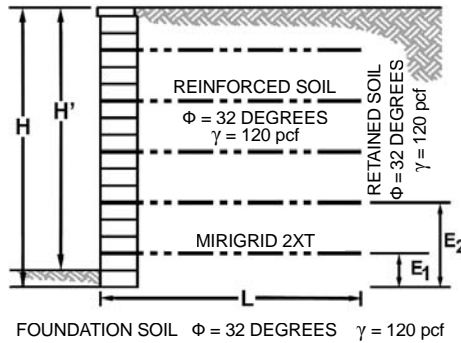

Exposed Height H', (ft)	Total Height H, (ft)	No. of Cast Stone Courses	Grid Layers	Length L, (ft)	Layer Number - Place Grid Elevation E _r (ft)							
					1	2	3	4	5	6	7	
2.3	2.8	5	1	4.0	1.5							
2.8	3.3	6	1	4.0	1.5							
3.3	3.8	7	2	4.0	1.5	2.5						
3.8	4.3	8	2	4.0	1.5	3.0						
4.3	4.8	9	2	4.0	1.5	3.0						
4.8	5.3	10	3	5.0	1.5	3.0	4.0					
5.3	5.8	11	3	5.0	1.5	3.0	4.5					
5.8	6.3	12	3	5.0	1.5	3.0	4.5					
6.3	6.8	13	4	6.0	1.5	3.0	4.5	5.5				
6.8	7.3	14	4	6.0	1.5	3.0	4.5	6.0				
7.3	7.8	15	4	6.0	1.5	3.0	4.5	6.0				
7.8	8.3	16	5	7.0	1.5	3.0	4.5	6.0	7.0			
8.3	8.8	17	5	7.0	1.5	3.0	4.5	6.0	7.5			

**Case 2 with $\phi = 32$ degrees
SURCHARGE FROM ROADWAY OR PARKING
NO SLOPE AT TOP OF WALL**

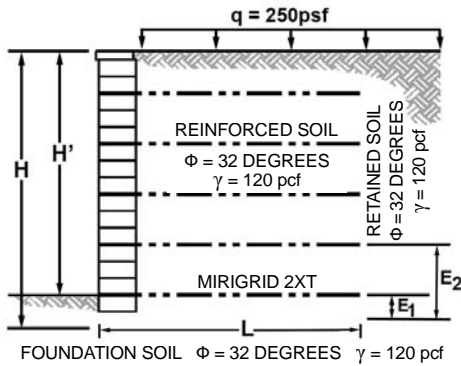

1.8	2.3	4	1	4.0	1.0							
2.3	2.8	5	1	4.0	1.0							
2.8	3.3	6	2	4.0	1.0	2.0						
3.3	3.8	7	2	4.0	1.0	2.0						
3.8	4.3	8	2	5.0	1.0	2.5						
4.3	4.8	9	3	5.0	1.0	2.5	3.5					
4.8	5.3	10	3	5.0	1.0	2.5	3.5					
5.3	5.8	11	3	6.0	1.0	2.5	4.0					
5.8	6.3	12	4	6.0	1.0	2.5	4.0	5.0				
6.3	6.8	13	4	6.0	1.0	2.5	4.0	5.0				
6.8	7.3	14	4	7.0	1.0	2.5	4.0	5.5				
7.3	7.8	15	5	7.0	1.0	2.5	4.0	5.5	6.5			
7.8	8.3	16	5	7.0	1.0	2.5	4.0	5.5	6.5			
8.3	8.8	17	5	8.0	1.0	2.5	4.0	5.5	7.0			

**Case 3 with $\phi = 32$ degrees
NO SURCHARGE
3:1 MAX SLOPE AT TOP OF WALL**

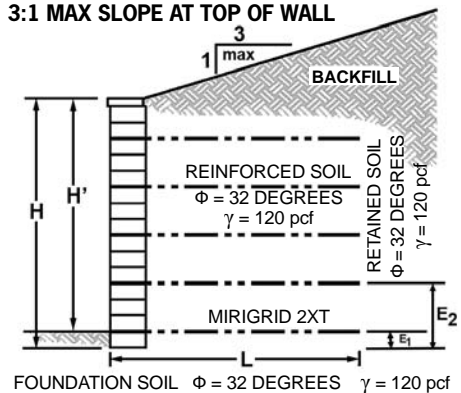

1.8	2.3	4	1	4.0	1.0							
2.3	2.8	5	1	4.0	1.5							
2.8	3.3	6	1	4.0	1.5							
3.3	3.8	7	2	4.0	1.5	2.5						
3.8	4.3	8	2	4.0	1.5	2.5						
4.3	4.8	9	2	5.5	1.5	3.0						
4.8	5.8	11*	3	5.5	1.5	3.0	4.0					
5.3	6.3	12*	3	6.5	1.5	3.0	4.5					
5.8	6.8	13*	3	6.5	1.5	3.0	4.5	5.5				
6.3	7.3	14*	4	6.5	1.5	3.0	4.5	5.5				
6.8	7.8	15*	4	7.0	1.5	3.0	4.5	6.0				
7.3	8.3	16*	4	8.0	1.5	3.0	4.5	6.0	7.0			
7.8	8.8	17*	5	8.0	1.5	3.0	4.5	6.0	7.5			

*REQUIRES TWO FULL COURSES BURIED

Notes:

- Information presented in this chart is to be used for preliminary design and estimating purposes. Final design should be performed by a Professional Engineer qualified in both geotechnical engineering and segmental retaining wall design.
- This estimating chart is applicable to sites where soil conditions meet the following minimum criteria: Angle of Internal Friction, $\phi > 32^\circ$ and moist unit weight, $\gamma = 120$ pcf. Typical for low plasticity silts meeting the following USCS classification: ML or coarser.
- Design charts prepared for use with EP Henry's Cast Stone Wall block system with Mirafi's type 2XT reinforcing geogrids. Grids MUST extend to the front face of the block.

4. Definitions:

- H' = exposed height, in feet
 - H = total height, in feet
 - L = length of Mirafi 2XT required, in feet
 - ϕ = angle of internal friction, degrees
 - γ = moist unit weight, pounds per cubic foot
- These charts do not reflect any provisions for global stability or other analyses, which may be related to site-specific conditions including relief of excess hydrostatic pressures due to groundwater or springs. All these conditions should be checked and evaluated as appropriate, using site specific soil and subsurface conditions, as well as any special loading criteria.
 - Design Minimum Factors of Safety: 1.5 for reinforcement

pullout, 1.5 for external sliding, 2.0 for overturning, and 2.0 for bearing.

- All walls shall be supported on an aggregate leveling pad and shall have adequate drainage provisions in accordance with EP Henry's standard specification guidelines.
- To the best of our knowledge, the information presented in this design chart is complete and accurate. However, EP Henry Corporation cannot assume any liability or accept any responsibility for the accuracy or completeness of this information. Further, EP Henry Corporation cannot assume any liability for damages arising from claims in which construction proceeded without final design drawings prepared by a Professional Engineer registered in the State of construction specializing in both geotechnical engineering and segmental retaining wall design.

WHAT TYPE OF FOOTING IS REQUIRED FOR EP HENRY WALL SYSTEMS?

A compacted stone base is required for all segmental retaining walls. EP Henry recommends 6" of dense graded aggregate for this purpose. Generally, the higher the wall, the thicker the base. You do not have to dig down below the frost line.

Please reference installation guides for specific recommendations on the base course for each wall system.

HOW TALL CAN I BUILD MY SEGMENTAL RETAINING WALL?

Height limitations without geogrid for all of our retaining wall products are listed within the catalog on the corresponding product pages. Designed and installed properly, segmental retaining walls can be built in excess of 50' high.

WHAT IS GEOGRID?

Similar in concept to a "dead man" used in the construction of railroad tie walls, geogrid stabilizes the soil mass behind the retaining wall and ties the wall face to the earth being retained. Typically made of polyester or HDPE, geogrids — such as Miraf® 3XT — are open-celled, directional fabrics that are placed between the layers of block at different intervals. Geogrids are then laid out perpendicular to the wall face in the compacted soil behind the wall. The height of the wall being constructed, the soil properties, and any pressure on the wall (e.g., slopes, structures, paved areas) all affect the length and placement of the geogrid. Additional information is available from EP Henry or a professional engineer.

WHAT DO I USE TO BACKFILL MY WALL?

The first 12" behind the wall should be backfilled with 3/4" clean stone to help relieve any hydrostatic pressure that might build up. The area directly behind the stone should be compacted soil. Use the same stone to fill the cores of Terrace Wall™, StoneWall® Select®, Diamond Pro®, Vertica® Wall, Coventry® Wall Plus, and Mesa® Wall.

I NEED STEPS IN MY RETAINING WALL. WHAT CAN I DO?

All EP Henry retaining wall products can be used to build steps. The wall units are used for

the riser and the caps for the treads (Bullnose Pavers can also be used for treads). Make sure you pay attention to local codes that dictate the minimum step height, tread depth, and hand rail requirements.

Note: Use of the EP Henry Filler Block to core fill steps will provide strength and stability to the step construction. The filler block is compatible with all 6" and 8" tall units.

SHOULD I USE A CORRUGATED PLASTIC PIPE (DRAIN TILE) BEHIND MY WALL TO DRAIN WATER AWAY?

Due to their mortarless construction, segmental retaining walls will naturally "weep" to relieve any hydrostatic pressure that builds up behind the wall.

As a rule of thumb, however, it's a good idea to use a drain tile directly behind the wall units at grade level for all wall applications.

HOW DO I MAKE 90 DEGREE CORNERS WITH EP HENRY SEGMENTAL WALL SYSTEMS?

Corner blocks with the rockface on two sides are available for the Terrace Wall, Coventry Wall, Tudor Wall, Double Sided Tudor Wall, Coventry Wall III, Stacked Stone, Double Sided Coventry Wall, Rustic Double Face Wall, Diamond Pro, Mesa Wall, Vertica Wall, and StoneWall SELECT systems. They are used for either left- or right-hand corners and are set in place with concrete adhesive.

CAN I MAKE A CURVED WALL WITH EP HENRY WALL SYSTEMS?

One of the many advantages over a railroad tie wall is that walls, with either inside or outside curves, can be built with all EP Henry wall systems. Blocks with tapered sides are used for outside curves, and inside curves can be created by placing the front corners together and gapping the units in the back.

WHAT DO I USE TO ADHERE THE CAPS ON MY RETAINING WALL?

Use a high strength, flexible concrete adhesive, such as Paver Bond®, to affix your wall cap.

WHAT IF I WANT TO BUILD A FREESTANDING WALL?

No Problem! EP Henry offers five creative options for walls that are functional and look great: Double Sided Coventry® Wall, Double Sided Tudor Wall™, Rustic Double Face Wall, Coventry® Wall III, and Double Sided Cast Stone Wall. Available in various heights and lengths, they are perfect for wing walls, knee walls, sitting areas, and more.

WHEN SHOULD I INVOLVE AN ENGINEER IN THE DESIGN OF MY WALL?

Use of a Professional Engineer is recommended on projects with taller walls (above 4') or with unusual site conditions (steep slopes, parking lot, structure behind the wall, or tiered wall). Local building codes may also necessitate the use of a professional engineer for walls above a certain height. Check with the local code officials before starting construction.

We can provide design charts and tables with generalized engineering solutions for some of our retaining wall systems. Each situation is unique, however, and specific evaluation will provide the most accurate solution.

WHAT ARE TIERED WALLS AND HOW DO I PLAN FOR THEM?

Tiered walls are two or more walls placed in a multi-level arrangement. The second wall should be located behind the first wall at a distance of at least twice the height of the first wall under ideal soil conditions (e.g., if the front wall is 3' high, the second wall should be at least 6' behind it).

Note: Consult a Professional Engineer.

EP Henry offers an extensive library of technical and construction information at ephenry.com/technical.

©2016 EPHenry. All rights reserved.



PRODUCT DESCRIPTION

EP Henry's Cast Veneer Stone is designed to provide a non-structural, lightweight veneer facing for both interior and exterior applications.

The product provides a quality architectural finish with all the colors, textures, sizes and shapes of quarried natural stone.

PRODUCT PACKAGING

All Cast Veneer Stone by EP Henry products are packaged with an anti-scuffing material between each layer of stone. This protects the product during packaging and shipping and protects against scuffing common with other veneer stone product lines.

Each Crate of EP Henry Cast Veneer Stone flats yields 100 sf

Each EP Small Pak of EP Henry Cast Veneer Stone flats yields 12 sf

Each Crate of EP Henry Cast Veneer Stone corners yields 75 lf

Each EP Small Pak of EP Henry Cast Veneer Stone corners yields 8 lf

EZ Fit Flats are packaged 5.625 sf per EP Small Pak/12 EP Small Paks per Crate

EZ Fit Corners are packaged 3 lf per EP Small Pak/12 EP Small Paks per Crate

CV Brick Flats are packaged 8 sf per EP Small Pak/32 EP Small Paks per Crate

CV Brick Corners are packaged 5.8 lf per EP Small Pak/32 EP Small Paks per Crate

Note: packaging quantities reflect approximate yield when erected in wall with typical mortar joints. Package yield will decrease when installing in a dry stack application.

FITTINGS

All fittings are packaged in EP Small Paks as follows:

Keystones	18 pieces
Electrical Fittings	20 pieces
Trimstones	24 pieces
Sills/Water Tables	10 pieces
Quoins	6 pieces
Hearthstones	4 pieces

Unit weight per SF: Maximum 15 psf (pounds per square foot)

PRODUCT WARRANTY

EP Henry provides a 50 year warranty to the original purchaser for Cast Veneer Stone when installed in accordance with the manufacturer's installation specifications. The warranty applies to Cast Veneer Stone units only and does not cover installation labor or damages resulting from improper installation or misuse of product.

PRODUCT GENERAL INFORMATION

Cast Veneer Stone should be applied only to structurally sound surfaces.

Cast Veneer Stone should not be used on exterior horizontal surfaces or as wall caps. Water collection on the units combined with freeze-thaw conditions can result in surface damage.

PRODUCT APPLICATIONS:

- New construction: interior or exterior walls
- Retro-fitting of existing interior and exterior walls
- Fireplaces, hearths and surrounds
- Chimneys

- Exterior Hardscaping masonry applications such as kitchens, built-in grills, columns and seat wall applications

Do not install product below grade or in a water environment.

Do not install in applications that expose the product to chlorine or chemicals, as discoloration may result. In fireplace and chimney applications, product should be kept at least 18" away from direct flame.

ESTIMATING STONE QUANTITIES

1. Determine the total square footage of the project (length times the height of each area). Remember to subtract the square foot area of all openings (doors, windows, etc.)
2. Calculate the linear footage of corner stones for the project. Remember to add all openings that require corner units. Convert the linear footage into square feet by multiplying by 1/2 (.5).

Note: As industry guidelines and building codes may change from time to time, for the most up-to-date standards, please visit www.masonryveneer.org

3. If using Architectural Trim Detail pieces or electrical outlet fittings, calculate the number of pieces required and the square footage. Remember to subtract this amount from the total square footage of Cast Veneer Stone flats.
4. Subtract square footage for corners from total square footage to determine the amount of flats required.
5. It is recommended that an extra quantity of flats (approximately 5%) be factored into the estimated materials to allow for cutting, trimming and the desired best fit.
6. Coverages stated for Cast Veneer Stone assume the use of a 1/2" mortar joint. When making linear and square footage calculations for dry stack applications, add 15% to 20% more to the materials calculation to compensate for the loss of the mortar joint space.

TYPES OF MORTAR

EP Henry recommends the use of a Type S mortar for Cast Veneer Stone installations.

Type S Mortar: 1 bag Type S mortar cement:
2½ to 3 cubic ft. mason's sand

Note: In accordance with good building practices, maintain materials and ambient air temperature in the work area at a minimum of 40 degrees F during installation and for 48 hours following the completion of work.

PREPARING THE SURFACE

For new clean CMU surfaces that have not been painted or treated in any way, Cast Veneer Stone can be applied directly to the surface. It is recommended that a bonding agent be applied to the masonry surface as well as a scratch coat to help strengthen the bond and minimize cracking.

For all other surfaces including poured concrete walls and on painted or treated masonry, self-furring metal lath (galvanized for exterior use) must be applied first followed by a scratch coat. (Installation diagrams available on request.). Most building codes and best building practices require that any nails, staples or screws that are used be galvanized.

Check the backs of Veneer Stones to make sure they are free of scale or a surface that readily flakes off. If that condition exists remove that surface film with a wire brush and dust off the backs of the units before wetting or applying mortar to the back of the stone.

SCRATCH COAT

An even, 1/2" thick coat of Type S mortar is applied to self-furring metal lath or clean masonry surface to help insure proper bonding of Cast Veneer Stone. The scratch coat should be allowed to set-up for 48 hours before installing the Cast Veneer Stone. If possible, after applying the scratch coat cover it with plastic to slow the curing process and reduce cracking which weakens the bond strength.

When using the dry stack method one should consider adding pigment to the scratch coat mortar mix that matches a darker color of the Cast Veneer Stone. That will prevent the gray scratch coat from being seen in any gaps between the stones and improve the look of the finished job.

STARTING THE INSTALLATION

Lay out a quantity of Cast Veneer Stone prior to installing. Make sure to select stones from as many boxes as possible to achieve the best possible mix of shapes, sizes, colors and textures. Continue this practice throughout the installation. Begin installing the stone from the top down. Start installing the corner units first. The corners have a long and short return which should be alternated in opposite directions as you go down the wall corner.

Try to maintain a uniform joint width (1/2") around the stones. Avoid long, unbroken joint lines. The stones can be trimmed using a brick hammer, nippers or the side of a mason's trowel. Stones can be cut more precisely with a hand held grinder or saw using a diamond or carborundum saw blade. Be sure to place the cut edges in unobtrusive places and touch up the cut with mortar when finishing the joints.

SETTING THE STONES

Apply an even layer of Type S mortar, approximately 1/2" thick, to the entire back of the stone leaving no area on the back of the stone exposed. Press the stone firmly into place on the wall surface. Press hard enough to squeeze the mortar out around the edges. If needed, strike off the excess mortar with a mason's trowel. To insure a good bond, gently wiggle the stone while pressing it in place. If any mortar gets on the stone face, DO NOT try to wipe it off. Allow the mortar to set and dry, then use a coarse brush to remove it. If working in hot, dry weather it may be necessary to wet the scratch coat and stone to prevent the mortar from drying too quickly and losing bond strength. The surface and back of the stone can be dampened with a hose but do not wet to excess. If too much water is applied and runoff occurs, allow a few minutes for the surface to dry before proceeding with the installation. If possible cover the scratch coat with plastic to slow the curing process and reduce cracking which weakens the bond strength.

DO NOT ALLOW construction (ex. hanging drywall, insulation, etc.) on the opposite side of the Cast Veneer Stone wall to take place until the stones have bonded and the mortar has cured properly (minimum of 48 hours).

Caution: Dry sawing or grinding of concrete products may result in the release of respirable crystalline quartz.

Prolonged exposure to respirable crystalline quartz may cause delayed (chronic) lung injury (silicosis). The use of a NIOSH-Approved respirator, tight fitting goggles and hearing protection is recommended when sawing or grinding operations are in progress.



▲ Cast Veneer Stone, River Rock



▲ Cast Veneer Stone, Cut Stone, Mortared



▲ Cast Veneer Stone, Pennsylvania Field Stone



▲ Cast Veneer Stone, LedgeStone, Dry Stack

GROUTING AND FINISHING THE JOINTS

Once all of the Cast Veneer Stone has been installed on the wall surface, use a grout bag and fill the joints between the stones with mortar making sure to fill all voids. It is recommended that a Type S or N mortar be used. The grouting mortar can be colored if desired.

When the mortar joints have begun to set and become firm to the touch, use a jointing tool to pack the joints and rake out the excess mortar to the desired depth. Make sure that all the edges of the stones are thoroughly sealed with mortar by pressing the mortar into place. Once the mortar joints have been worked, use a soft, hand whisk broom or paint brush and smooth the joints while cleaning away any loose mortar from the stones.

DRystack INSTALLATION

Dry stack installation follows the same guidelines as normal installation with a few key differences:

1. Install from the bottom up.
2. Stones should be wetted regardless of air temperatures, bearing in mind that work should not be conducted in temperatures below 40 degrees F. If the scratch coat is dry, wet the wall as you go.
3. Use a chalk line and a 4' level to periodically level individual stones during installation.
4. As there will be no mortar joint strengthening the bond, it is important that ample mortar is applied to the back of each stone covering it 100% with enough mortar to ensure it squeezes out around the edges when pressed in place. Mortar should not be stiff to allow the joint to seal to the next stone. After setting stone, use a trowel to remove excess mortar and fill any voids along the stones' edges.

CLEANING

It is always recommended that a test of the cleaning method be done in an inconspicuous location prior to proceeding with the overall

cleaning. Cleaning materials and methods appropriate for other masonry surfaces may not be suitable for Cast Veneer Stone.

GENERAL MAINTENANCE

- To clean dirt or dust, use a garden hose and a soft bristle brush
- Mild detergents can be used but should be rinsed immediately
- DO NOT use a wire brush
- DO NOT use acid based products or a pressure washer to clean stone

EFFLORESCENCE REMOVAL

- Allow Cast Veneer Stone to dry completely
- Gently scrub with a nylon stiff bristle brush and rinse thoroughly with clean water

Note: As industry guidelines and building codes may change from time to time, for the most up-to-date standards, please visit www.masonryveneer.org

Cleaning Products

EP Henry offers a complete line of cleaners from Techni-Seal to maintain the beauty of your pavers.

PROFESSIONAL GRADE OIL & GREASE REMOVER

- Removes motor oil and other greasy stains
- Dissolves, dislodges, and encapsulates grease

PAVER PRIMER

- Dislodges efflorescence and ground-in dirt
- Ensures even cleaning and brightens the color
- Concentrated — one gallon cleans up to 200 sf
- Automatic dilution with adaptable sprayer*
- Recommended PRIOR TO PROTECTOR application

*Sprayer available through EP Henry Authorized Hardscaping Distributor®



CLEANED PAVERS

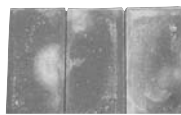

PAVERS WITH EFFLORESCENCE

HARDSCAPE CLEANER

- Multi-surface cleaner
- Dislodges ground-in dirt
- Ensures even cleaning and brightens color
- Concentrated — one gallon cleans up to 800 sf
- Recommended PRIOR TO PROTECTOR application

PAINT, TAR, AND RUBBER REMOVER

- Effectively dissolves paint, tar or bitumen, rubber, and chewing gum
- Also available in five gallon containers to remove sealers

RUST REMOVER

- Effectively removes stains caused by steel, rusted metal objects, fertilizer, etc.
- Won't discolor pavers

Sealers

Sealing is recommended to preserve the original beauty of EP Henry Pavers and to resist stains. EP Henry is pleased to carry the Techni-Seal® line of high performance sealers, offering several options for protecting and maintaining the beauty of your EP Henry Pavers. Dirt, stains, and efflorescence must be treated with the appropriate Techni-Seal cleaning product prior to sealing.

Adhesives

PAVER BOND POWERSEAL® ADHESIVE

An easy to apply, quick curing, and flexible high strength adhesive for paving stones, retaining walls, and other hard surface applications.

TECHNI-SEAL® RG ADHESIVE

Perfectly resist the elements including frost and rain, super-adherent on dry, wet, or frozen surfaces; ideal for retaining walls.

Paver Edge Restraint

The purpose of Edge Restraint products is to restrain paver's lateral motion. Without a proper Edge Restraint System, pavers are prone to shifting. EP Henry offers the Snap Edge Paver Restraint System.

Note: See diagram of typical installation on page 2.



ADVANTAGES OF THE SNAP EDGE RESTRAINT SYSTEM:

- One piece system does it all; straight, curves, or even a complete radius, without waste
- An 8' piece transports easily and requires no extra connectors
- Open base design allows for grass growth along paver edge creating a strong yet invisible edge
- Patented snap and spike together ends for a secure connection and extra support
- Rugged injection molded plastic ensures the strongest edge designed for vehicular and patio/walkway applications
- Can be installed before or after the pavers have been laid
- Easy to install with common 8"-12" landscape spike
- Convenient and efficient packaging, easy to handle

Sand Stabilizers

TECHNI-SEAL POLYMERIC SANDS

Techni-Seal offers three high quality Polymeric Sand products for pavement joints. Both resist erosion of joints, inhibit weed growth, and resist insect penetration. They are available in two colors: Tan and Granite Gray.

"RG+" — Ideal for normal traffic areas including driveways, patios, and walkways.

"HP2" — Specially formulated for wider joints and heavier traffic areas, such as sloped driveways, pool decks, and public areas. Also performs better in high-humidity applications.

Additional features of both:

- Premixed with sand so it's ready for immediate use
- Bonding commences upon spraying with fine mist of water
- "RG+" can be installed at 55°F or above
- "HP" can be installed at 40°F or above
- Will not stain pavers
- Complete installation instructions are on the back of the bag

Next Gel Jointing Sand

Techni-Seal now offers Next Gel, designed for wider joint applications and areas with heavy slopes, traffic and humidity.

The revolutionary technology behind Next Gel provides these benefits:

- No dust
- No haze
- No waste
- 50% faster wetting
- 40% faster installation

Separation Fabric

Mirafi® 500x geotextile fabric is recommended for use with all paver installations. Its primary purpose is to keep the base material from working its way into the soil underneath, thus reducing the possibility of settling.

The material should be flat over the excavated area, with as few wrinkles as possible, and turned up on the sides to cover the sides of the stone base material. It will also prevent migration of the bedding sand into cracks, joints, and weep holes in or next to the pavement.

This product, which costs only pennies per square foot, is an inexpensive insurance policy for your pavement.

Note: See diagram of typical installation on page 2.



Polymeric Sand must be installed per the manufacturer's guidelines. The user should have an up-to-date Techni-Seal technical product data sheet and should view the video of the RG+ installation procedure at: www.techniseal.com. The misapplication of Techni-Seal Polymeric Sand could generate a polymeric haze on the surface.

Techni-Seal Polymeric Sand must NOT be applied to wet or damp surfaces. Do NOT mix Techni-Seal Polymeric Sand with cement, sand or any other chemicals. Do NOT use on submerged or constantly wet surfaces. Use on pavers or slabs installed over a free draining sand-setting bed and compacted dense aggregate base as ICPI recommends. It is not recommended for use on concrete overlay construction or stone dust.

A NOTE ABOUT PAVER ACCESSORIES

EP Henry has researched many lines of accessory products for use with our pavers and wall systems. While there may be other similar products on the market, please note that EP Henry approves and recommends using only those accessory products shown in our catalog.



Adhesives

EP Henry offers a variety of adhesives for wall applications:

SUREBOND PAVER BOND

- High strength structural grade adhesive
- Durable formula withstands extreme wear and tear, including heavy vehicular traffic
- Sets quickly in only 10 minutes
- Freeze-thaw stable
- Naturally shims

TECHNI-SEAL® RG

- Strong, durable bond
- Flexible, ideal for concrete retaining wall applications
- Can be used on wet or frozen surfaces (allow longer curing time)
- Economical

Geogrids

EP Henry offers the highest quality geogrids for SRW applications.

Please note: Mesa UX Grid must be used on all Mesa SRW applications.

MIRAFI® GEOGRID	SOLD BY
1XL 20 SQUARE YARD ROLL (4'x45')	ROLL
2XT 33.3 SQUARE YARD ROLL (6'x50')	ROLL
3XT 200 SQUARE YARD ROLL (12'x150')	ROLL
5XT 200 SQUARE YARD ROLL (12'x150')	ROLL
8XT 267 SQUARE YARD ROLL (12'x200')	ROLL
UX MESA GRID	SOLD BY
UX1100 121 SQUARE YARD ROLL (4.36'x250')	ROLL
UX1400 121 SQUARE YARD ROLL (4.36'x250')	ROLL
UX1500 96.9 SQUARE YARD ROLL (4.36'x200')	ROLL
UX1600 96.9 SQUARE YARD ROLL (4.36'x200')	ROLL
UX1700 96.9 SQUARE YARD ROLL (4.36'x200')	ROLL

Sealer

EP Henry offers Techni-Seal WR7 natural look, water based sealant for concrete retaining walls. It helps prevent efflorescence and damage caused by de-icing salts while preserving the natural look of your wall.



▲ Geogrid

SLEEVE-IT® SYSTEM FROM STRATA When Your Wall Needs a Fence

The Sleeve-It® System is a patented, code compliant, fence-post anchoring system that integrates stable fence footings into the support structure of walls while the retaining wall is being constructed. This unique fence systems is pre-engineered and pre-designed so that the useable real estate at the top of a retaining wall is not wasted. Using the system as part of the Segmental Retaining Wall (SRW) eliminates a 3 foot offset requirement for rails and fences that are added after wall construction, reducing specifier liability and associated costs with building-code compliance. Sleeve-It® also offers a below grade engineered design that provides superior safety in a cost effective solution.

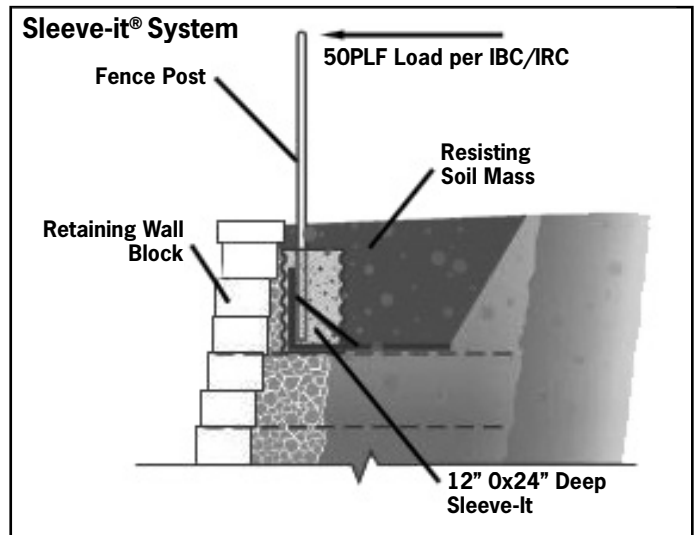



INSTALLATION INSTRUCTIONS FOR KERR LIGHTING PRODUCTS FROM SEK-SUREBOND

Please read all instructions thoroughly before beginning and follow them carefully when installing your project.

These instructions can be used for Kerr Paver Lights™, Retaining Wall Lights, Garden Wall Lights, Deck & Dock Lights and Wallter and Cornelius Wall Lights.

1. Draft a layout of your project showing the location where the transformer will be plugged in and the desired location of your lights. Lights are typically placed 5-8 feet apart for good lighting distribution but you may prefer otherwise.

2. Make sure you have the materials and tools needed to complete your installation. You'll need:

- Lights, each including
 - light base
 - light lens
 - lamp socket(s)
 - lamp(s) (bulbs)
- Connectors (2-per light)
- Low voltage power supply cable
- Transformer
- Tools: Pliers, Wire Cutters

3. Split one end of the power supply cable and remove about 1/8" - of the insulation on each side to expose the copper wire inside. Connect each side to the knobs on the back of the transformer.



4. Mount the transformer outdoors near a plug. Transformers placed near swimming pools or other water sources should be plugged into a GFCI-protected outlet and the control unit should be mounted at least 10 feet from the edge of the water. Do not plug in the transformer until all lights have been installed.

5. All Kerr Paver lights come preassembled with the bulbs in the sockets which are attached to the base.



6. Run the low voltage cable which will supply power to the lights around the perimeter of your project. For installation with segmental pavers, you may set the cable atop the bedding sand under the border course of pavers to keep it from being damaged when digging in the yard and so it can be easily located. Remember to leave enough slack for connection of the light to the power cable.

7. When using the silicone connectors split the power supply cable down the middle without exposing the copper where the lights are to be located. **Note that one side of the cable is ribbed and one is smooth. See back of sheet when using the brown connectors.**

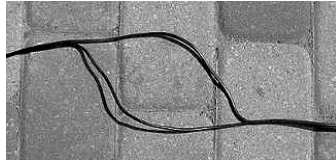

8. Examine the connectors and note there are three holes in each. The outside holes are for the power cable and the middle hole is for the lead from the fixture. Cut one side of the split power supply cable. There is no need to strip the insulation. Place each end of the cut power cable into the two outside holes in the connector. Push one of the cables from the light fixture into the middle hole. Visually make certain all three wires are pushed to the back of the connector.



9. Squeeze the connector with a pair of pliers, pushing the black cap down until it is flush with the clear plastic housing. Make certain that all three wires remain at the back of the connector during this process. Crimping will require a bit of force as you are forming the connection between all three wires. The connectors contain a silicone gel, which coats the connection and protects it from moisture. It is normal for some of the silicone to squeeze out during the crimping. Wipe off excess with a rag, taking care not to get it on your clothing.



10. Repeat steps 8 & 9 with the other side of the power supply cable and the remaining lead from the fixture. You should end up with two connections per light as shown. After all lights have been attached, plug in and switch on the transformer to test all connections.



Note: When you reach the last light on the string, you will only use two holes on each connector as shown.



Paver Lights are available in:

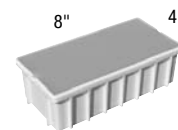

BRICK STONE



COVENTRY® STONE I
OLD TOWNE COBBLE™
VILLAGE SQUARE®



COVENTRY STONE I
OLD TOWNE COBBLE



11. Connectors should be buried below the pavers in the sand setting bed, in the ground, or in the stone behind retaining and garden walls.

12. Set the light fixture in its place. Make sure adjacent pavers sit on the "L" shaped feet that come with some Paver Lights or on the extended bottom plate that is part of the light base on others to hold down the light. Run the wiring under or around the existing or new pavers.



13. Install the light lens.

14. The enclosed silicone connectors should only be used with 16 gauge cable, the brown connectors should be used with 12 gauge cable.

Installation using brown saddle connectors (included with some Light Kits): Can only be used with 12 gauge cable.

Split the power supply cable down the middle without exposing the internal copper wire. Do not cut the cable in half.

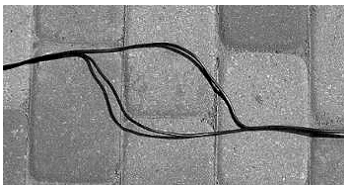

Straddle one side of the split power supply cable with the connector and insert one of the wires from a light (either white or black) in the other hole in the connector as shown. Then crimp the connector with pliers and repeat the process for the other half of the of the low voltage cable. You should have two connectors per light.

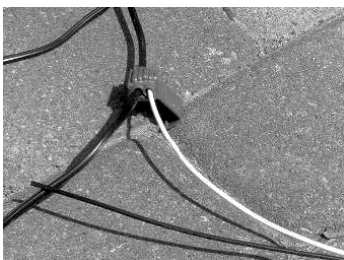

▲ Integral Wall Lights



▲ Surface Mounted Wall Lights



▲ Wallter - use under walls caps, pillar caps, and steps



▲ Cornelius - use on outside corners underneath pillar caps

Important Notes:

- Kerr Light Kits include transformers which are sized to accommodate the number of lights included in the Kit. Should you decide to add lights to the Kit, and when planning your project, the wattage of the transformer must exceed the total wattage of the lights on the power cable. For example, if your project includes 10 lights on a string, each with a 7 watt bulb, the transformer must exceed 70 watts of power (10 lights x 7 watts each).
- The closer your lamps are placed to the transformer, the higher their voltage (and wattage) readings will be. Those farthest away will have lower voltages. If a cable run is too long or if too many lights are being powered by a single transformer, noticeable voltage drop may occur. Voltage drop causes the lights farthest from the transformer to become dim.

Voltage drop can be minimized by:

- using a heavier gauge cable (Kerr Lighting recommends a maximum power cable length of 100 feet on 16/2 cable and 300 feet for 12/2 cable)
- using a transformer with greater wattage
- using multiple transformers
- shortening cable lengths
- reducing the total number of fixtures on a run
- When using Kerr Paver Lights in a new installation, light lenses can be scratched by plate compactors if not protected. Please cover the lens with cardboard or a similar protective material to ensure that it does not become damaged during compaction.
- To prevent lens discoloration do not apply paver cleaners or sealers to the light lens.
- Accessory and replacement parts, including lenses and colored bulbs, are available.

Square Foot Calculations

L x W + Sq. Ft.

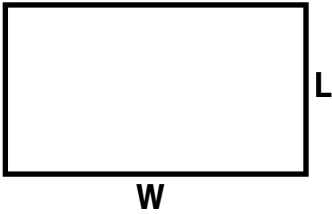

1/2 Base x h = Sq. Ft.

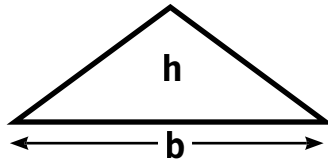

$\pi r^2 = \text{Sq. Ft.}$

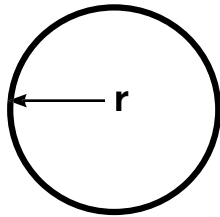

$\pi = 3.1416$

Basic Conversions

Cubic Measure	27 cubic ft. = 1 cubic yd.	- 40 cubic feet = 1 ton
Volume	1 cubic cm = .061 cubic ins.	- 1 cubic in. = 16.39 cm
Long Measure	3 ft. = 1 yd.	
Square Measure	9 sq. ft. = 1 sq. yd.	

Approximate Weight Materials

1 cubic yd. 2A (Modified)	1.35 tons/2,700 lbs.
1 cubic yd. 2B (Clean)	1.30 tons/2,600 lbs.
1 cubic yd. Mason's Sand	1.30 tons/2,600 lbs.
1 cubic yd. Concrete Sand	1.35 tons/2,700 lbs.
1 cubic yd. Dry Common Earth	1.1 tons/2,215 lbs.

Note: 1 Ton = 2,000 lbs.

Handy Base Information

1,000 lbs. of sand will cover approx. 100 sq. ft. with a 1" depth
 1,000 lbs. of 2A modified stone will cover approx. 100 sq. ft. with a 1" depth

Base Calculation Formula:

Square Feet x Base Thickness / 27 x 1.35 = Tons of Material

Value to Enter for Base Thicknesses:

1" Sand	0.08
4" Base	0.33
6" Base	0.50
8" Base	0.67
10" Sand	0.83

Example using 100 sq. ft. w/o 6" base: 100 x .5/27 x 1.35 = 2.5 Tons of 2A

Using the 3 - 4 - 5 Method

Most smaller projects can be squared using a framing square or other small squares. When you are building a larger project you need a technique to make sure everything is square to the starting point. The beauty of this method is that you use inches, feet, yards or any unit of measurement. This accommodates very large and small projects.

Tip: You can also modify the measurements by doubling or tripling each one, example 3 4 5, 6 8 10, 9 12 15. Get the idea?

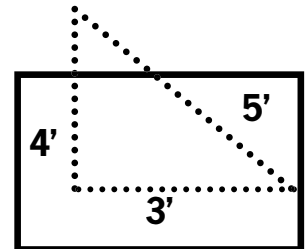

Overdig Stabilization Detail

Construction Sequence

1. Excavate 4' deep from original grade by 4' wide within construction area.
2. Thoroughly compact subgrade with plate tamper (centrifugal force not to exceed 4,000 lbs.).
3. Install 2" thick rigid foam insulation against basement wall.
4. Place separator fabric of base & top up face of excavation and basement wall, minimizing wrinkles.
5. Place 2B stone in 6" compacted fills to paver/stair subgrade. Compact each fill starting at basement wall and work outward.
6. Place next 6" fill of 2B stone and compact from basement wall working outward. Repeat fill placement and compaction as necessary.
7. Wrap separator fabric over top of 2B stone as shown to encapsulate.
8. Construct stairs/paver section per manufacturer's recommendations.
9. These recommendations are predicted upon the assumption that reasonable suitable soil (not excessively saturated) is exposed to a depth of 48" below original subgrade. If unstable soils exist at this elevation, excessive settlement of the structure may occur over time.

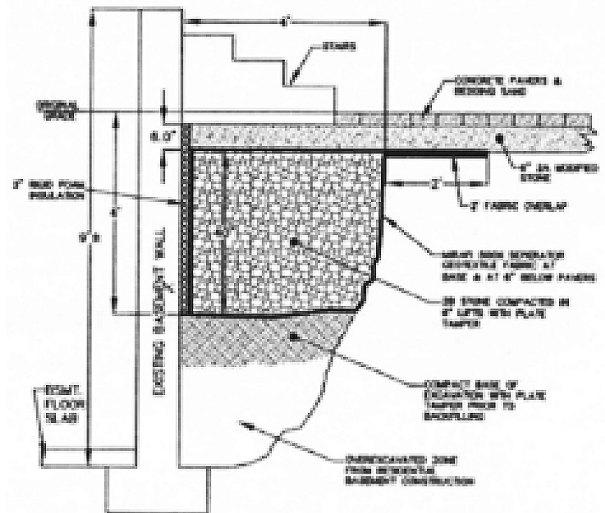



CORPORATE HEADQUARTERS

201 Park Avenue

PO Box 615

Woodbury, New Jersey 08096

www.ephens.com

800 44 HENRY

FX: 856 845 0023

